

COUNTRY[®] ESTATE FENCE



RESIDENTIAL FENCE PLANNING & INSTALLATION GUIDE

(See reverse side for Rail Installation)

TABLE OF CONTENTS

Description	Page No.
General Information.....	3
Planning Your Project.....	3
Sketch a Layout.....	3
Slope.....	4
Post Centering.....	4
Post Depth.....	5
Post Footings.....	5
Gates.....	7
Gate Posts.....	7
Typical Fastening Techniques.....	8
Installation Guide.....	9
Residential Fence Styles:	
The Alton™.....	12
The Arlington®.....	13
The Bellflower®.....	14
The Boston (and Boston w/Lattice)®.....	15
The Brighton™.....	12
The Caribbean®.....	16
The Clarendon®.....	13
The Clayton™.....	12
The Dalton®.....	12
The Dartmouth®.....	13
The Dawson™.....	17
The Denver®.....	18
The Exeter®.....	13
The Georgetown®.....	19
The Hampton® (straight, scallop & step).....	20
The Hannibal®.....	21
The Hanver®.....	18
The Hollingsworth™.....	23
The Kensington®.....	22
The Lakeland® (standard, concave, convex & heavy duty).....	23
The Lincolnshire®.....	24
The Malibu®.....	25
The Marseille®.....	27
The Melbourne® (and Melbourne w/Lattice).....	28
The Montauk™.....	26
The Montauk Point™ (straight, scallop & step).....	26
The Nantucket™.....	19
The Rochester™.....	29
The Springfield®.....	30
The Windsor®.....	31

For more information on



COUNTRY®
ESTATE
FENCE

Call Toll-Free
1-800-445-2887



NEBRASKA PLASTICS, INC.
P.O. Box 45 • Cozad, NE 69130 • FAX (308) 784-3216

GENERAL INFORMATION

Country Estate Fencing is known for its ease of installation. Other than the need to allow for greater expansion and contraction than is typical with traditional fencing materials, all of the techniques used by experienced fence installers are directly applicable to Country Estate Fencing products. This guide shares techniques developed by experienced installers and is offered to make your installation as easy and as professional as possible.

PLANNING YOUR PROJECT

There are a number of decisions you must make before ordering your Country Estate Fence. Although each project is different, there are some considerations which are common to every project. The following information is offered to assist you. If you have questions not covered here, please ask your Country Estate representative for assistance.

SKETCH A LAYOUT

Drive stakes to locate proposed corner posts and gate posts. Look for obstacles in the proposed fence line (trees, bushes, structures, etc.). Measure the distances between the stakes and take a few moments to sketch a layout of your project. Consider which direction you want your gates to swing. Some neighborhoods have building codes which restrict fence height and set back from property lines. If you are planning a property line fence, you will want to confirm your property lines before ordering your fence.

KNOW ABOUT LOCAL ORDINANCES

Building permits are typically required in most new installations. Local codes may require clearances or have height restrictions. Where an existing fence is being replaced, permits are not usually required — but it is good to investigate before beginning.

CHECK WITH YOUR LOCAL UTILITY COMPANIES

As a safety precaution, allow the utility companies to mark the location of buried lines, pipes and/or cables. Most companies will do this free of charge.



**All Country Estate® PVC Products
may be Recycled.**

SLOPE

All properties have some slope. On nearly level properties, the top rail of the fence is kept level and the adjustment for slope is made by varying the post height. Rail and picket fencing will conform more easily to sloping or rolling terrain than will privacy fencing. If the drop is significant (2" +), your privacy fence may need to be installed using the stair-step method.



How to check for slope.

Mark the string where it intersects the stake.

Mark this stake when level reading is attained.

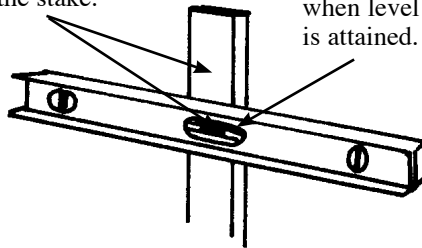

During the planning stage, this simple and inexpensive slope-gauging method may be used to determine the need for slope allowance. During construction, your installer will use a transit or laser.

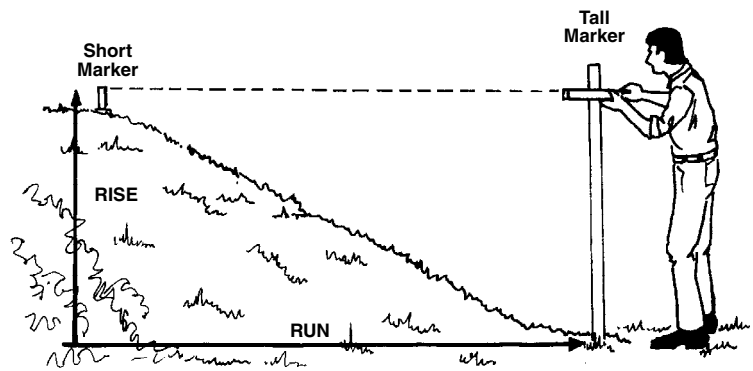

POST CENTERING

There are regional differences regarding preferred post spacing. On most residential fencing, posts are spaced on 4', 6' or 8' centers. If you're planning an installation in rocky soil, 6' and 8' centers will reduce labor considerably. If your property is in a windy or hurricane area, 4' centers will provide added support. This is particularly true if you are erecting a solid privacy fence. In high traffic areas, 4' centers may be better. Please check with regional installers for their suggestions.



CAUTION

HEAVING:

Heaving occurs when the ground freezes to a depth below the bottom of the post while the soil in that area is saturated with water. Fencing may have been installed several years with no misalignment having occurred due to heaving. Then, if for some reason the soil freezes to a greater than usual depth or freezes with an increased amount of water in the soil, heaving can occur. The increased soil moisture can come from heavy rains, flooding, or having the ground water level rise. When heaving occurs, check the soil moisture and determine if excess water can be drained away from the post areas.

POST FOOTINGS-INSTALLATION OF POSTS (IN ACCORDANCE WITH ASTM F1999)

Adequate post footings are required to assure a straight and level fence for the life of the material. The following sketch shows four different accepted footings, for specific conditions. Due to the added stability provided, concrete is generally preferred. You may use either wet concrete or a dry-pre-mix concrete. Dry-pre-mix has the advantage that it can be backfilled and tamped like dirt. This allows installers to continue working and not have to wait for the concrete to set. Dry-pre-mix concrete draws moisture from the earth and after seven to ten days it will be as strong as wet concrete.

Due to the added stability provided, concrete is generally preferred; however, in some areas, dirt fill is used.

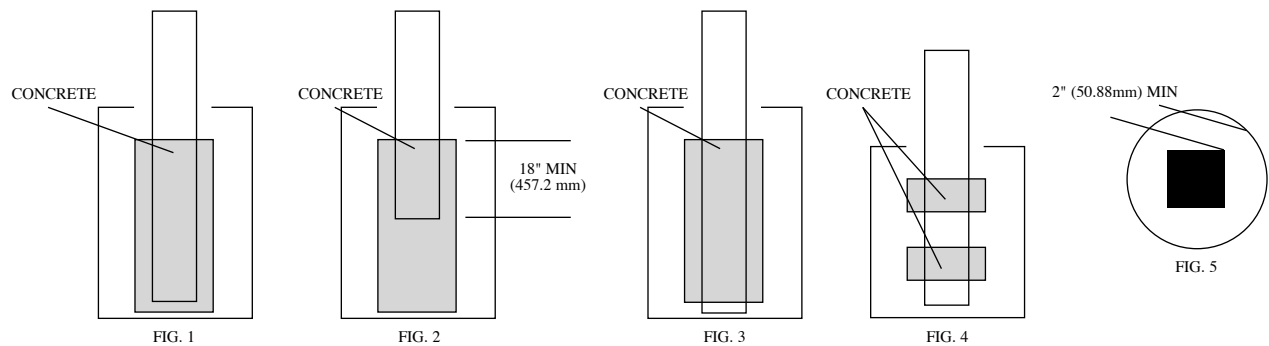

Preparation of Post Holes:

Set posts in concrete in holes of diameter and depth as follows. Intended use and local conditions shall determine post-footing dimensions, that is, under normal conditions the diameter shall be 4 in. (101 mm) greater than the largest cross section of the post. The depth shall be a minimum of 24 in. (609 mm) plus an additional 3 in. (76 mm) for each 1-ft. (305 mm) increased fence height over 4 ft. (1.22 m). In areas where frost is common, the footing shall extend a minimum of 6 in. (152.4 mm) below the maximum frost level.

Preparation of Post – To secure post vertically, provide a means such as, but not limited to, notching, drilling, roughing, pinning, etc.

Installation of Posts:

This practice includes three post-setting methods. Method 1 should be used where there are mucky or loose soil conditions.

Method 1 – Partially fill holes with concrete, then set the post into the concrete leaving approximately 2 to 4 in. (51 to 101 mm) of concrete below the bottom of the post (see FIG.1) Continue filling the hole with concrete to within 6 to 9 in. (152.4 to 228.6 mm) of the top. Fill the remainder of the hole with soil or fine rocks. Where frost is not likely, the hole may be filled to ground level with concrete (see Note1). The post shall extend a minimum of 18 in. (457.2 mm) into the concrete (see FIG. 2). Check to see that the post remains plum until the concrete has set.

Note 1 – Filling hole to top with concrete in frost areas will enhance upheaval of post and footers as concrete freezes faster than fill.

Method 2 – Tap the post into the bottom of the hole until the desired height of the post above ground level is reached (see Note 2 and FIG. 3). Add concrete around the post to the level specified in Method 1. Check to see the post remains plumb until the concrete has set.

Note 2 – This method should not be used where there are mucky or loose soil conditions as without concrete under the post, it may sink if downward pressure is applied.

Method 3 – Tap the post into the bottom of the hole until the desired height of the post above ground level is reached (see FIG.4) Fill the hole one fourth of the depth with concrete, then add fine rocks or gravel, or fine rocks (see Note1). Check to see that the post remains plumb until the concrete has set.

Even if concrete is not used on line posts, it should be used on corner posts and gate posts (See “For extra fence post stability”). Your post will be best stabilized if the post hole provides room for a minimum of 2”-3.5” of firmly compacted dirt or concrete on all sides of the post.

For extra fence post stability,

the following suggestions should be considered:

- The option of a double-wall post versus a single-wall post.
- When longer (wider) gates are used, additional concrete should be placed around base of posts.
- Remember, all sections should be in place before securing posts with rebar and concrete (such as end posts, corner posts, or gate posts).

Note: The recommendation of filling posts with concrete is for end posts, corner posts, and gate posts only. Filling the inside of all posts with concrete will restrict the expansion and contraction of the rails!

The following method of securing an end post, corner post or gate post will improve stability and prevent sagging gates.

Method 1 – Steps

- 1. Dig Post Hole (10" or 12" dia.)**
NOTE: When using larger heavier gates, hole diameters should be kept at 12" or bigger.
- 2. Drill holes near bottom of post, spaced approximately 4" from bottom, 6" apart. Place 1' lengths of 1/2" rebar in holes.** (Allow approximately equal amounts on each side of post).
- 3. Set post and place concrete around post base.**
- 4. Put sections together and fill post with concrete.**
NOTE: Cover ends of rails or section rails with duct tape to prevent concrete seepage into rails.
- 5. Push rebar down through wet concrete inside of post.** (5" x 5" post, 2 lengths of 1/2" rebar; 4" x 4" and 3 1/2" x 3 1/2" post, 1 length of 1/2" rebar)
NOTE: Rebar should be as long as post.
- 6. Mount all hardware and/or place brackets on post while concrete is wet.**
NOTE: by doing this step last, it will help prevent air pockets in concrete around screws and rebar.

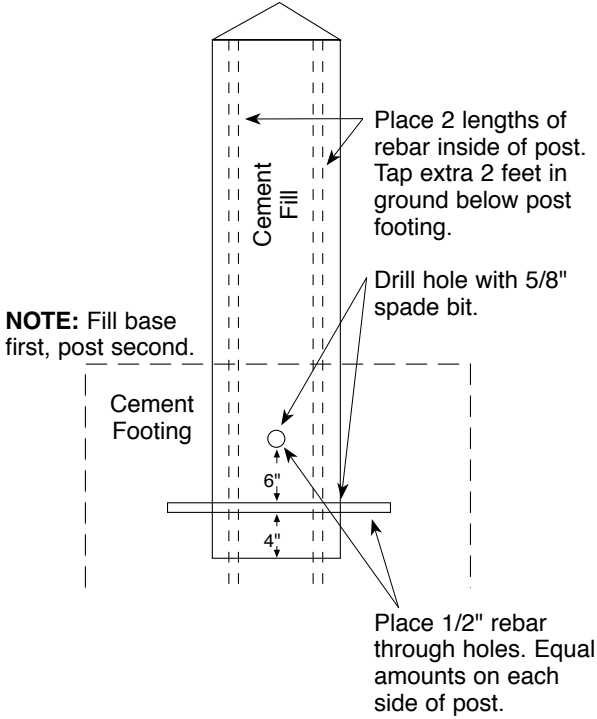

Method 2 – Country Estate Fence carried aluminum post inserts that greatly assist in post stability, also by using aluminum post inserts there is less time needed for concrete to set as it is only at the base of the post. This really helps reduce installation times generally as a rule by one day.

Infill is the material placed around the post at and above ground level. Infill aids in water drainage and runoff. This is sometimes called crowning. Keeping water away from the posts aids in maintaining alignment.

IMPORTANT: The installation of posts on the exact centers recommended for each fence style is the most critical step in vinyl fence construction because exact centers will allow for expansion and contraction. The second most critical step is proper alignment.

GATES

Give considerable thought to the convenient location, adequate width, and proper installation of your gates. They will be the most visible part of your fence project. Gates are the high traffic point. If they are the wrong size, or if they do not swing conveniently, they can be an annoyance. The following items are provided to help you plan the appropriate gate size and hardware.

- Will you need both walk-through and drive-through gates?
- Check the width of vehicles, wheelbarrows, lawn mowers, etc. Openings for gates for automobiles should be a minimum of 8' wide. In high traffic areas, you will want the gate opening to be 10' or 12' wide.
- For an opening wider than 5', double gates may be preferred.
- Which direction do you want the gate to swing?

GATE POSTS

Your gate will be not better than the post on which it is hung. If the weight of the gate causes it to shift in the soil, it will appear that your gate is sagging and it may not open properly. To assure a trouble-free installation, the gatepost must be extremely stable. It should be mounted in an extra amount of concrete. Fill the inside of the post with concrete reinforced with rebar, or aluminum post inserts are available for 3.5", 4", and 5" gate posts, rather than using concrete and rebar. If an aluminum post insert is used, extend it well below the concrete used to stabilize the post in the posthole. You may also wish to use these same installation procedures on your latch posts.

When hanging gates, CEF recommends the use of aluminum posts insert inside the gatepost as discussed above. As an alternative method, we have seen the use of a gate post which extends above the gate and a supporting cable is strung from the top of the gate post to the far end of the gate. You may have a rust problem with the cable system. **CAUTION:** The cable system should not be used where animals are present because it is possible for them to get their heads wedged in the angle created where the cable attaches to the top of the gate. **EXTREME CAUTION:** The cable system is also a hazard for small children who may play on the gate.

Remember: If your gate requires a bolt/screw through the post and/or latch or if the hardware screws into the gate and/or latch post, mount your hardware on the posts while the concrete is still wet. If you are using aluminum inserts this will not be necessary, but the pre-drilling of screw holes will be, to help facilitate securing hardware.

Country Estate® installation practices and recommendations does not purport to address all of the safety concerns and/or local code requirements, associated with it's use. It is the responsibility of the user of these prescribed installation practices to establish appropriate safety, health, and installation practices and determine the applicability of regulatory limitations prior to use.

Safety — All work shall be performed in safe and orderly fashion in accordance with the Williams-Steiger Occupational Safety and Health Act of 1970.

TYPICAL FASTENING TECHNIQUES:

POST TO HORIZONTAL (RAIL):

ROUTED POST / INSERTED RAIL:

Our most popular rail-mounting method. The central mounting makes the fence appear the same from either side. In this technique, the post is routed and the rail inserted. Twin notches are made on both sides of each rail and as the illustration shows, the horizontals are easily inserted, but will not slip out after snapping into the post.

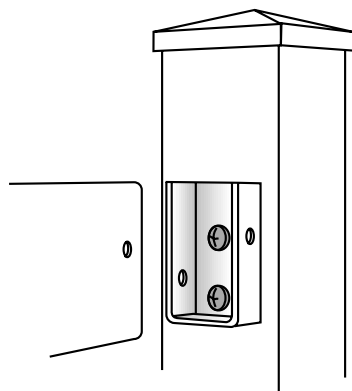

Trim off approximately 3/8" of the inside corner of the 1 3/4" x 3 1/2" horizontal

3 1/2" x 3 1/2" Corner Post

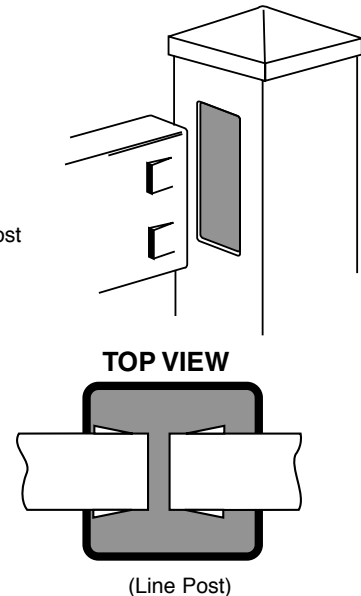
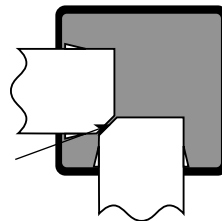

POCKET MOUNTED RAILS:

Ideal for installations on uneven or sloped yards where fence sections are stair-stepped or when you wish to be able to remove a section of fence easily. The pocket-mounts have pre-drilled holes for securing horizontals and preventing "lift-out" of a rail or fence section.

SECURING VERTICAL (PICKET) TO HORIZONTAL (RAIL):

Our traditional technique for securing vertical pickets to the horizontal framework is to first drill a 5/8" dia. hole in the backwall of the horizontal, reach through the hole and mount a screw through the front wall of the horizontal and into the vertical pivot. Unlike the wooden fence fastened in this manner, moisture retention between the members will never promote rot. A polyvinyl circular plug then caps the backwall 5/8" hole. It may be easily removed for any future need.

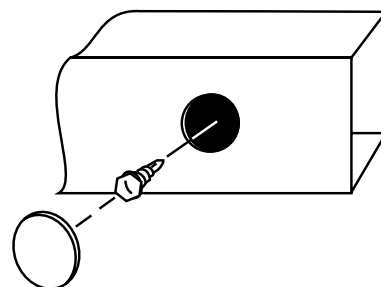
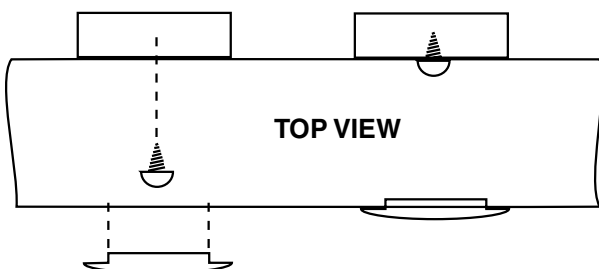

INSTALLATION GUIDE:

(For all residential styles) Some styles will need to be installed on level ground or stair stepped and others will work good on uneven ground. Your dealer will be able to assist you with your choices.

Note: A list of tools needed for the installation of each fence style is shown above the respective drawings which are shown on pages 14 through 30.

Note: These instructions assume the Bellflower, Boston, Boston w/Lattice, Hannibal, Hanver, Georgetown, Marseille, Nantucket and Springfield picket sections are pre-assembled.

Steps:

1. Set a String Line at the outer edge of the desired post location.

Important: Due to the expansion and contraction caused by temperature changes, it is very important that your posts are set on exact centers. This is more easily accomplished if you use a string line with the spacing pre-marked on the string line. Some professional installers use a pre-marked, spring-loaded cable with hooks on the ends so that the cable can be easily unhooked and pulled aside as the post hole is dug. See sketch.

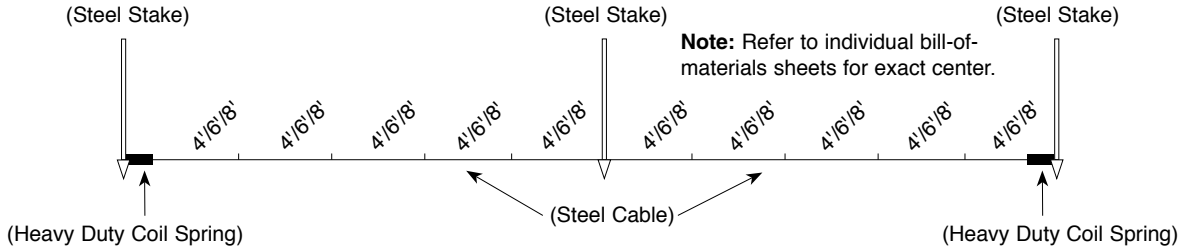

With either a conventional string line or the steel cable, the stakes should be very secure to maintain accuracy.

- 2. **Mark the location of each post hole.** A can of brightly colored spray paint works well for marking post holes.
- 3. **Dig Post Holes and Set Posts.** In ground-frost areas, dig the post hole a few inches deeper than the desired post depth. Backfill the first few inches with gravel. This will reduce frost heave.

In ground-frost-free areas, dig the post hole slightly shallow. Set the post in the hole, place a block of wood on the top of the post, and use a mallet to tap the post down to the desired height. This provides a solid base for the post.

Use your string line, carpenter's level, and tape measure to make certain that each post is set exactly on center, that each post is exactly perpendicular, and that both the top and the bottom of each post center is on exact centers.

If you backfill with dry-mix concrete, tamp and pack the backfill tightly. If you backfill with wet concrete, use care not to slop the concrete onto the post. Make certain each post is the correct height.

- 4. Pop the Rails of Pre-assembled Picket Sections (Routed Sections) into Routed Post Holes.** The rail-ends are notched to hold the rails into the posts. If your posts are spaced on exact centers, the rails will appear to be slightly longer than necessary. Do not allow the rail-ends to abut on the inside of the post. When properly installed, rails will have a small amount of side to side "float". This "float" allows for the expansion and contraction of the rails.
- 5. Install Lattice on fences using lattice with the stainless-steel screws provided.** Install the u-channel that holds the bottom of the lattice to the top of the privacy panel and then install the u-channel to the post. Drill starter holes for screws. Slip the lattice in from the top, into the u-channel. Clip the top on the u-channel and insert the top rail. Fasten the top rail to the top u-channel with screws and cap plug holes.
- 6. Install Caps and Rail Plugs.** On external caps, place a small bead of PVC cement on the inside of the cap lip. On internal caps, place a small bead of PVC cement on the inside of the post.
- 7. Clean Fence.** During installation, your fence will have collected dirt and finger marks. These may be wiped off with "Soft Scrub" or a comparable product. Light solutions of bleach and water will work. Some professional installers wipe down the fence with rags and lacquer thinner. Lacquer thinner works very well, but use it sparingly and do not let it pool on the PVC.



Post placement is important, using a stringline and level to assure vertical alignment.



Once the post is aligned, cement or a cement-water mix will make it permanent.



CAUTION

Failure to follow recommended installation procedures will result in loss of Manufacturer's Warranty. Alternate procedures or post spacing in excess of 8' will require a Written Authorization from Nebraska Plastics, Inc. to retain warranty rights.

Country Estate® installation practices and recommendations does not purport to address all of the safety concerns and/or local code requirements, associated with it's use. It is the responsibility of the user of these prescribed installation practices to establish appropriate safety, health, and installation practices and determine the applicability of regulatory limitations prior to use.

Safety — All work shall be performed in safe and orderly fashion in accordance with the Williams-Steiger Occupational Safety and Health Act of 1970.



Posts are set for the entire installation.



Prebuilt fence sections or horizontals are then mounted to or through the routed posts.



Sections or rails are added until the fence is complete.

The Alton™ — The Brighton™ — The Clayton™ — The Dalton®

MATERIALS REQUIRED FOR INSTALLATION:
Stakes — String/Cable — Post Hole Digger/Auger — Leveling Blocks
— Level — Mallet — Concrete/Dry Mix — Measuring Tape

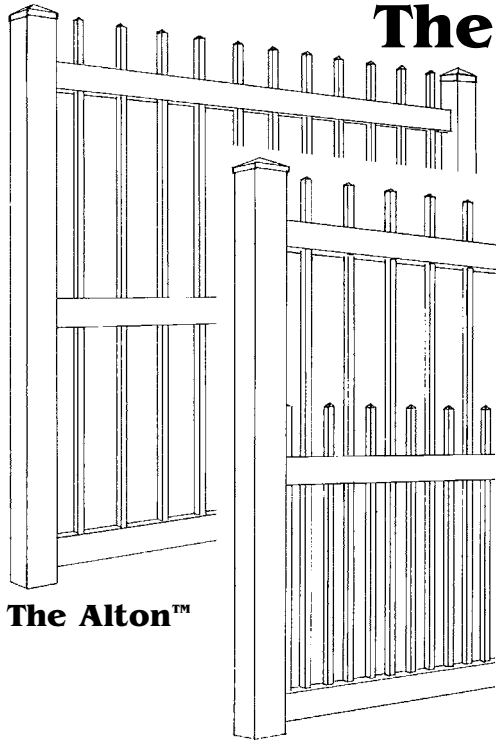

The Alton™

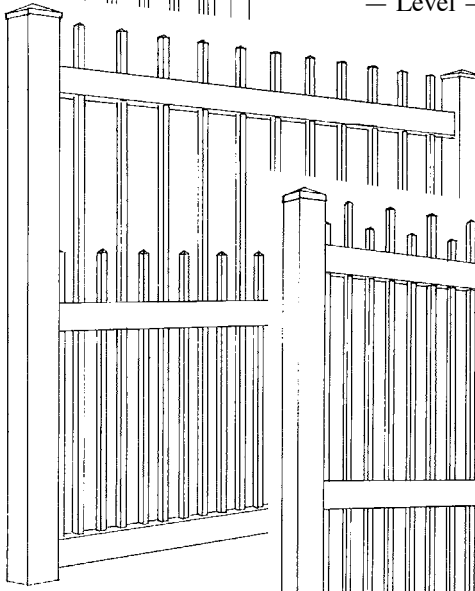

The Brighton™

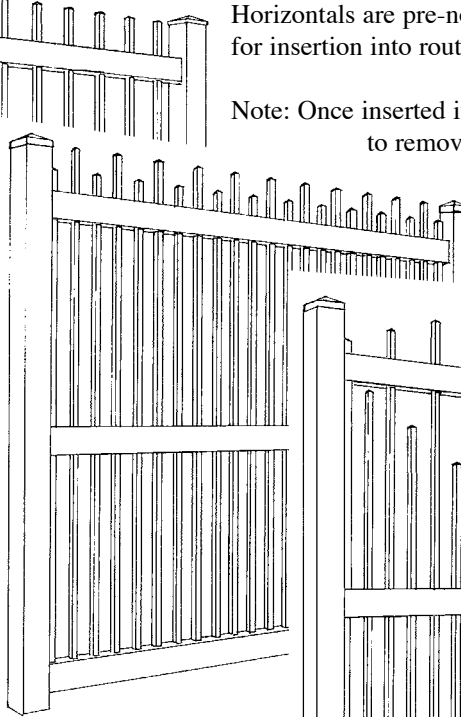

The Clayton™

Horizontals are pre-notched each end for insertion into routed holes.

Note: Once inserted it is difficult to remove horizontal.

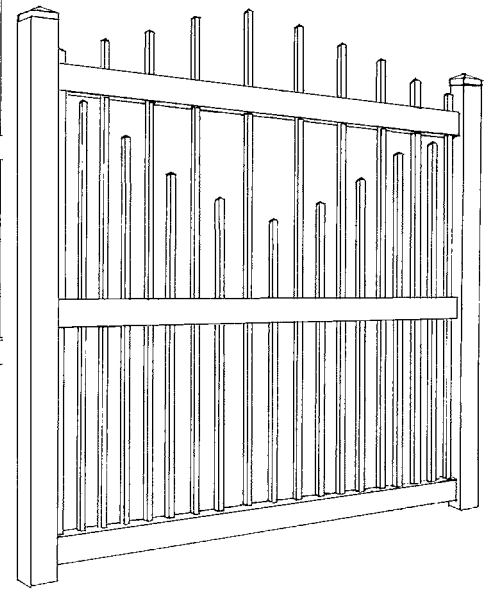
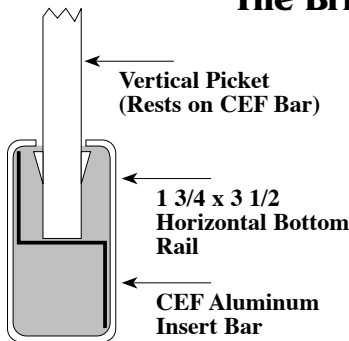
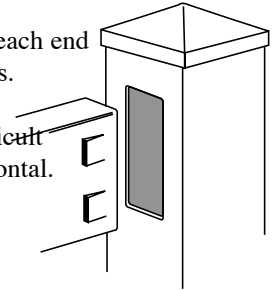

The Dalton® U.S. Pat. No. D380,557

**STANDARD ALTON, BRIGHTON,
CLAYTON, & DALTON DIMENSIONS**

Standard Height Options:	48", 60", or 72"
Post Spacing Options: (Notice - Posts must be exactly centered to allow for expansion.)	6' center-to-center
Post Dimensions:	48" High Fence = 4" x 4" x 72" 60" High Fence = 4" x 4" x 96" 72" High Fence = 4" x 4" x 108"
Standard Post Depth: (Local conditions may require additional depth.)	48" High Fence = 24" Post Depth 60" High Fence = 36" Post Depth 72" High Fence = 36" Post Depth
Horizontal Dimensions:	3 1/2" Wide x 1 3/4" Thick
Pickets (Verticals)	
Alton Spacing:	5" Between Pickets
Brighton & Clayton Spacing:	2" Between Pickets
Dalton Spacing:	2 1/8" Between Pickets
Picket Dimensions:	1" x 1"
Ground Clearance: (Grade variations will cause inconsistent ground clearance measurements.)	2"

The Arlington® — The Clarendon® — The Dartmouth® — The Exeter®

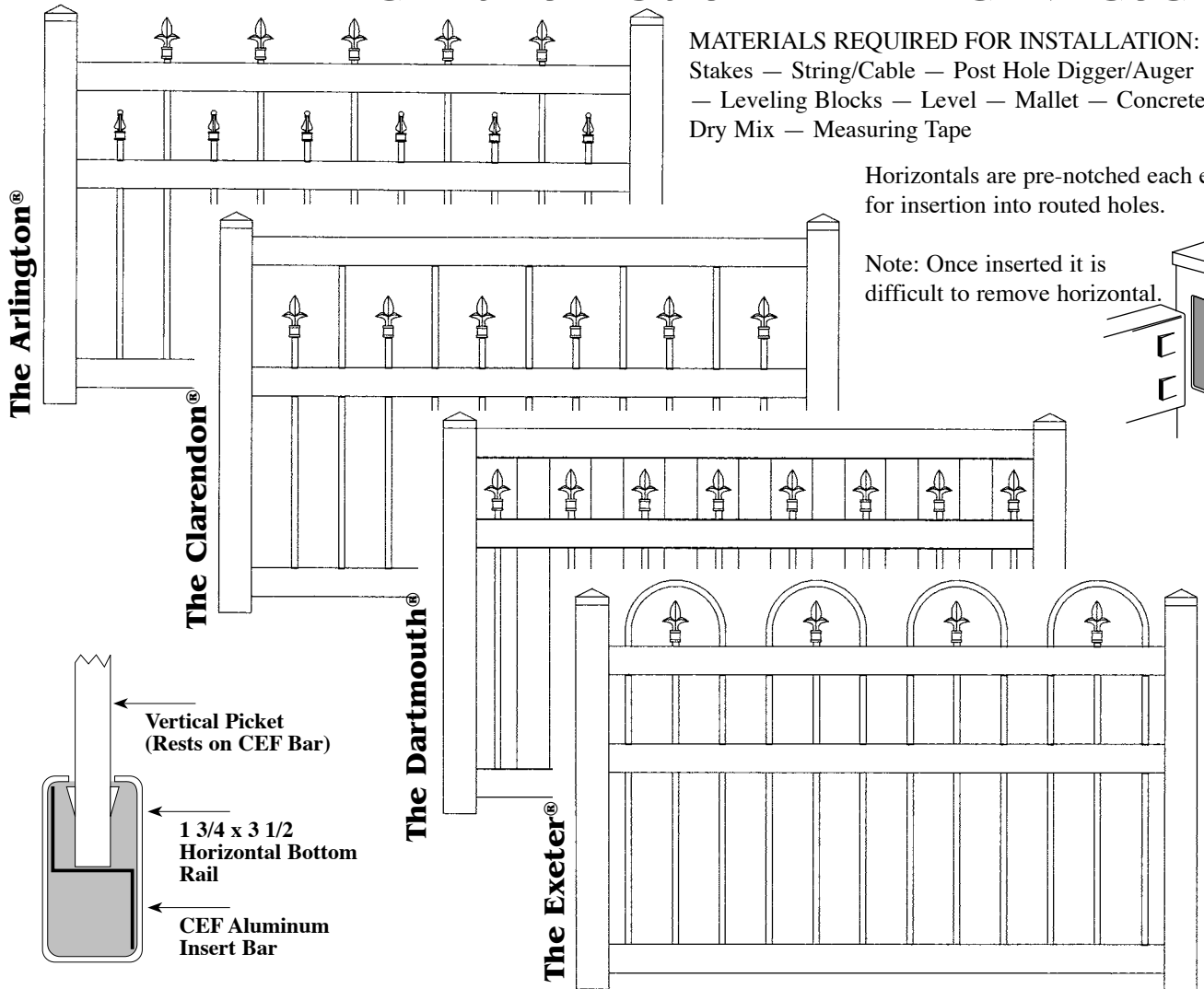

MATERIALS REQUIRED FOR INSTALLATION:
Stakes — String/Cable — Post Hole Digger/Auger
— Leveling Blocks — Level — Mallet — Concrete/
Dry Mix — Measuring Tape

Horizontals are pre-notched each end for insertion into routed holes.

Note: Once inserted it is difficult to remove horizontal.

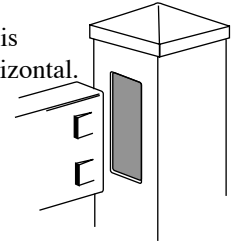

STANDARD ARLINGTON, CLARENDON, DARTMOUTH, & EXETER DIMENSIONS

Standard Height Options:	48", 60", or 72"
Post Spacing Options: (Notice - Posts must be exactly centered to allow for expansion.)	6' center-to-center
Post Dimensions:	48" High Fence = 4" x 4" x 72" 60" High Fence = 4" x 4" x 96" 72" High Fence = 4" x 4" x 108"
Standard Post Depth: (Local conditions may require additional depth.)	48" High Fence = 24" Post Depth 60" High Fence = 36" Post Depth 72" High Fence = 36" Post Depth
Horizontal Dimensions:	3 1/2" Wide x 1 3/4" Thick
Pickets (Verticals)	
Arlington, Clarendon, & Exeter Spacing:	5" Between Pickets
Dartmouth Spacing:	2" Between Pickets
Picket Dimensions on Arlington, Clarendon, & Exeter:	3/4" x 3/4"
Picket Dimensions on Dartmouth:	3/4" x 3/4" and 1" x 4"
Ground Clearance: (Grade variations will cause inconsistent ground clearance measurements.)	2"

The Bellflower®

MATERIALS REQUIRED FOR INSTALLATION:

Stakes — String/Cable — Post Hole Digger/Auger — Leveling Blocks — Level — Mallet — Concrete/Dry Mix — Measuring Tape — Radial Arm Saw/Hacksaw may be needed — Hammer

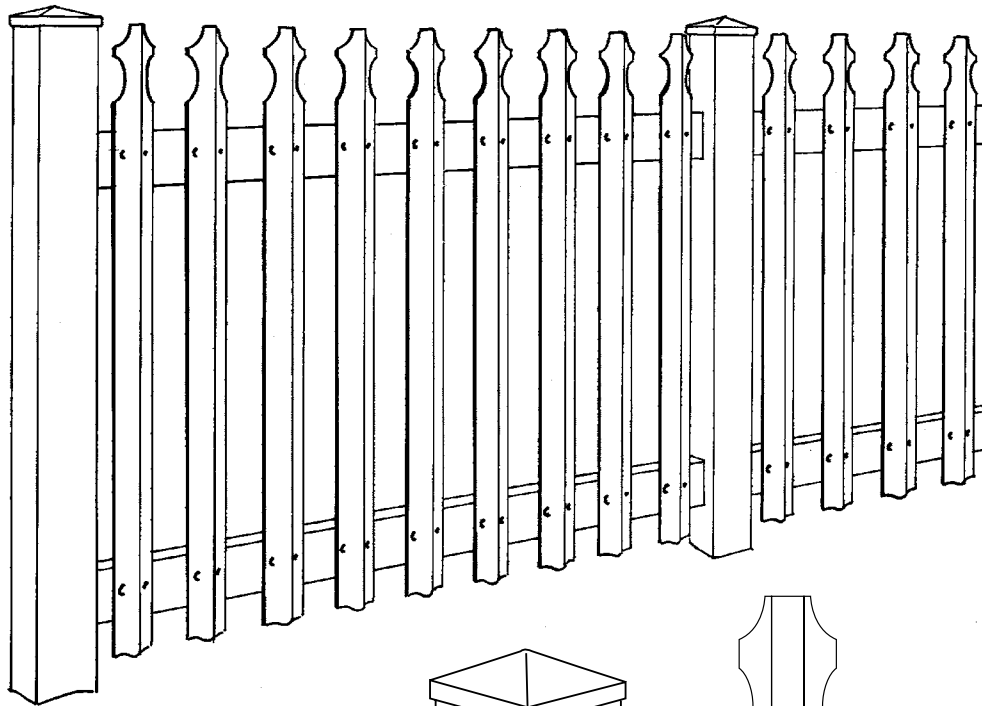

3 1/2" x 3 1/2" Corner Post

Trim off approximately 3/8" of the inside corner of the 1 3/4" x 3 1/2" horizontal

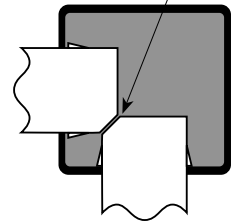

Horizontals are pre-notched each end for insertion into routed holes.

Note: Once inserted it is difficult to remove horizontal.

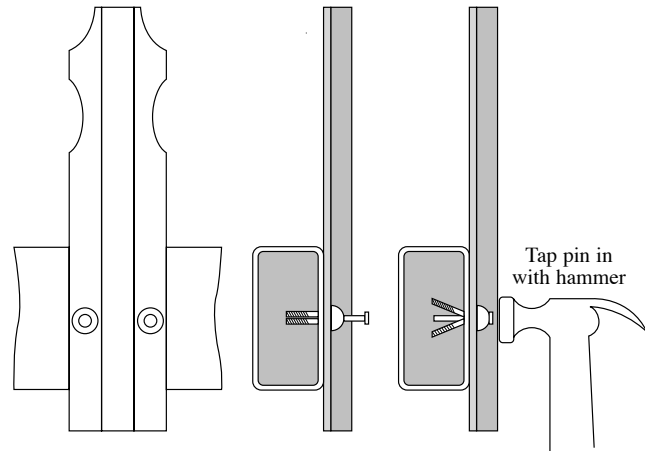
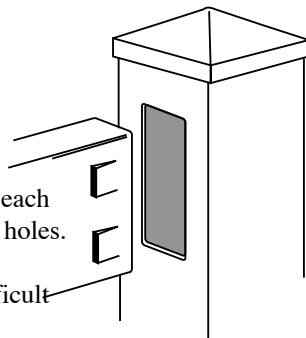

STANDARD BELLFLOWER DIMENSIONS	Standard Height Options:	36", 42", or 48"
	Post Spacing Options: (Notice - Posts must be exactly centered to allow for expansion.)	4' or 6' center-to-center
	Post Dimensions:	36" High Fence = 3 1/2" x 3 1/2" x 60" 42" High Fence = 3 1/2" x 3 1/2" x 66" 48" High Fence = 3 1/2" x 3 1/2" x 72"
	Standard Post Depth: (Local conditions may require additional depth.)	36" High Fence = 24" Post Depth 42" High Fence = 24" Post Depth 48" High Fence = 24" Post Depth
	Horizontal Dimensions:	3 1/2" Wide x 1 3/4" Thick
	Pickets (Verticals) 4' Post Spacing: 6' Post Spacing: Picket Dimensions:	2 3/4" Between Pickets 2 9/16" Between Pickets 2 1/2" Wide x 1/8" Thick
	Ground Clearance: (Grade variations will cause inconsistent ground clearance measurements.)	2"

The Boston® (and Boston w/Lattice)

MATERIALS REQUIRED FOR INSTALLATION:
 Stakes — String/Cable — Post Hole Digger/Auger
 — Leveling Blocks — 5/16" Socket with Drill Extension
 — Drill/Speed Drill — Level — Mallet — Concrete/Dry
 Mix — Measuring Tape

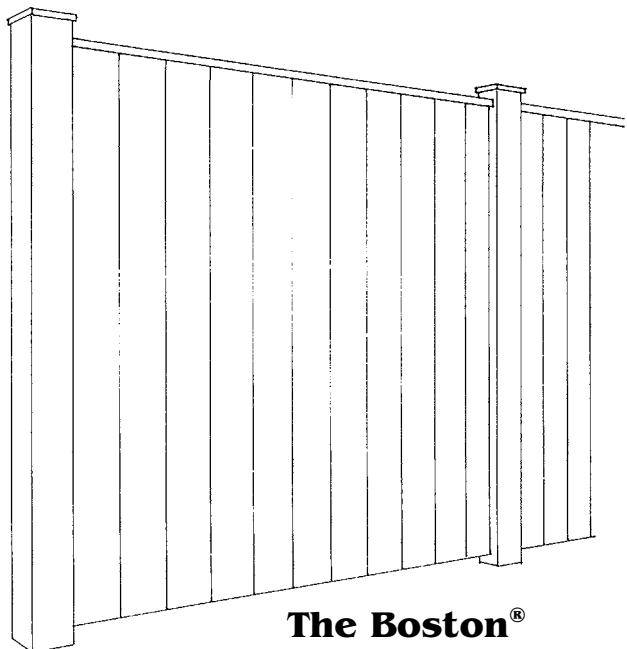

The Boston®

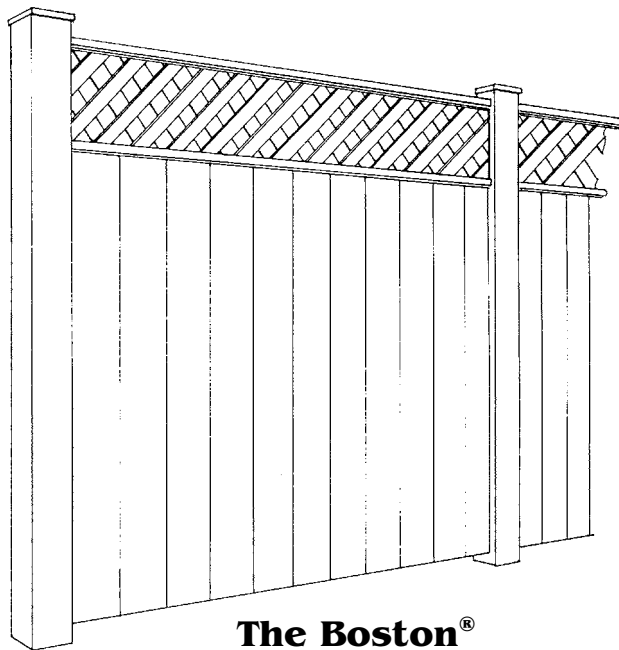

**The Boston®
with Lattice**

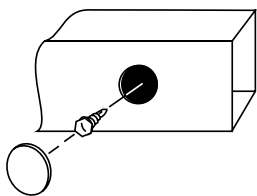

Verticals are secured to the horizontals with a No. 12 hex head screw. Capplugs cover the screw head on the horizontal.

Note: Vertical 1" x 6" should be secured to 1 3/4" x 3 1/2" cross members prior to inserting in routed holes.

Horizontals are pre-notched each end for insertion into routed holes.

Note: Once inserted it is difficult to remove horizontal.

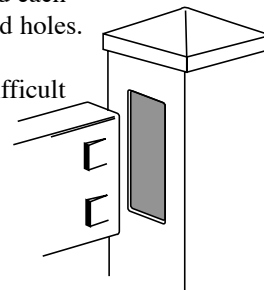

**STANDARD
BOSTON DIMENSIONS**

Standard Height Options:	48", 60", or 72"
Post Spacing Options: (Notice - Posts must be exactly centered to allow for expansion.)	3.9' or 5.9' center-to-center
Post Dimensions:	48" High Fence = 5" x 5" x 84" 60" High Fence = 5" x 5" x 96" 72" High Fence = 5" x 5" x 108"
Standard Post Depth: (Local conditions may require additional depth.)	48" High Fence = 36" Post Depth 60" High Fence = 36" Post Depth 72" High Fence = 36" Post Depth
Horizontal Dimensions:	3 1/2" Wide x 1 3/4" Thick
Pickets Dimensions (Verticals)	6" Wide x 1" Thick
Ground Clearance: (Grade variations will cause inconsistent ground clearance measurements.)	2"

The Caribbean®

MATERIALS REQUIRED FOR INSTALLATION:
 Stakes — String/Cable — Post Hole Digger/Auger — Leveling
 Blocks — Level — Mallet — Concrete/Dry Mix — Measuring Tape

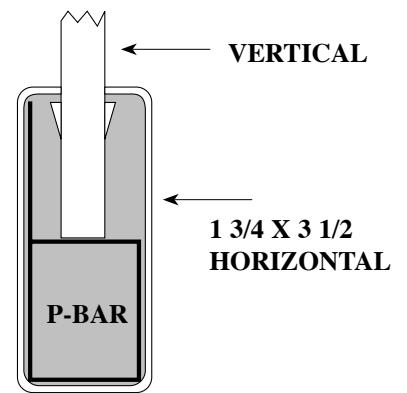
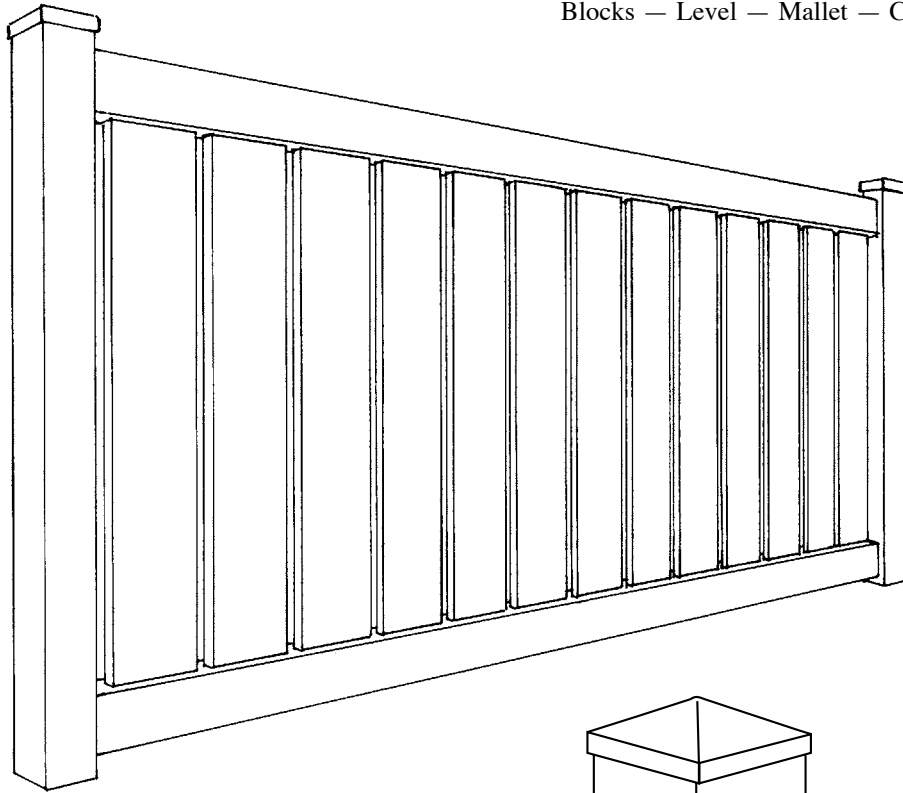

Horizontals are pre-notched each end for insertion into routed holes.

Note: Once inserted it is difficult to remove horizontal.

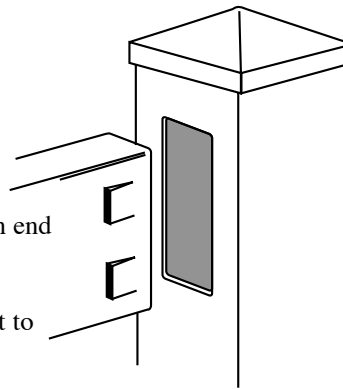

STANDARD CARIBBEAN DIMENSIONS	Standard Height Options:	48", 60", or 72"
	Post Spacing Options: <small>(Notice - Posts must be exactly centered to allow for expansion.)</small>	6' or 8' center-to-center
	Post Dimensions:	48" High Fence = 4" x 4" x 72" 60" High Fence = 4" x 4" x 96" 72" High Fence = 4" x 4" x 108"
	Standard Post Depth: <small>(Local conditions may require additional depth.)</small>	48" High Fence = 24" Post Depth 60" High Fence = 36" Post Depth 72" High Fence = 36" Post Depth
	Horizontal Dimensions:	3 1/2" Wide x 1 3/4" Thick
	Pickets (Verticals) 6' Post Spacing 8' Post Spacing Dimensions	3/4" Between Pickets 1" Between Pickets 6" Wide x 1" Thick
	Ground Clearance: <small>(Grade variations will cause inconsistent ground clearance measurements.)</small>	2"

The Dawson™

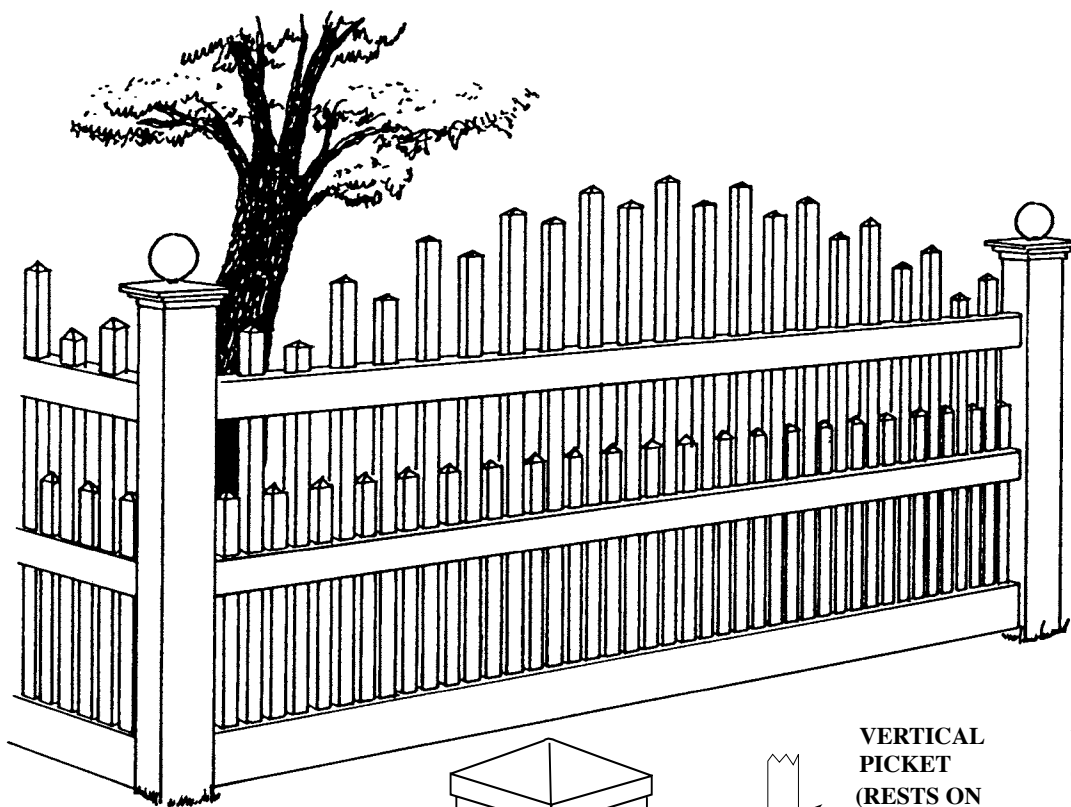

Horizontals are pre-notched each end for insertion into routed holes.

Note: Once inserted it is difficult to remove horizontal.

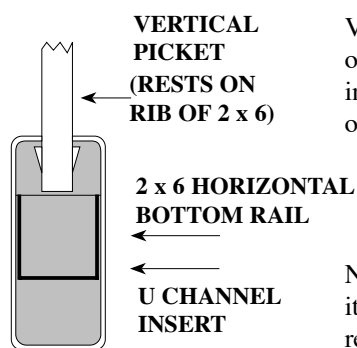
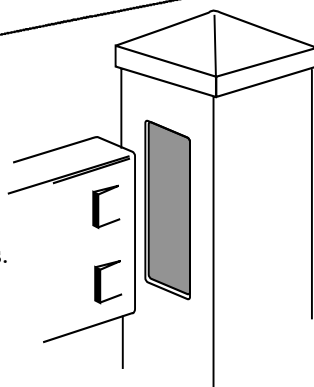

VERTICAL PICKET (RESTS ON RIB OF 2 x 6)

2 x 6 HORIZONTAL BOTTOM RAIL

U CHANNEL INSERT

Verticals are pre-notched on the bottom only for insertion into routed holes on the 2 x 6 horizontal.

Note: Once inserted it is difficult to remove horizontal.

STANDARD DAWSON DIMENSIONS

Standard Height Options:	48", 60", or 72"
Post Spacing Options: (Notice - Posts must be exactly centered to allow for expansion.)	8' center-to-center
Post Dimensions:	48" High Fence = 5" x 5" x 72" 60" High Fence = 5" x 5" x 96" 72" High Fence = 5" x 5" x 108"
Standard Post Depth: (Local conditions may require additional depth.)	48" High Fence = 24" Post Depth 60" High Fence = 36" Post Depth 72" High Fence = 36" Post Depth
Standard Post Cap:	5" x 5" New England with Post Ender
Horizontal Dimensions:	2" Thick x 3.5" Wide (Top) 2" Thick x 3.5" Wide (Middle) 2" Thick x 6" Wide (Bottom)
Picket Dimensions (Verticals)	1 1/2" Thick x 1 1/2" Wide
Ground Clearance: (Grade variations will cause inconsistent ground clearance measurements.)	2"

The Denver® — The Hanver®

MATERIALS REQUIRED FOR INSTALLATION:
 Stakes — String/Cable —
 Post Hole Digger/Auger
 — Leveling Blocks — Level
 — Mallet — Concrete/Dry Mix
 — Measuring Tape

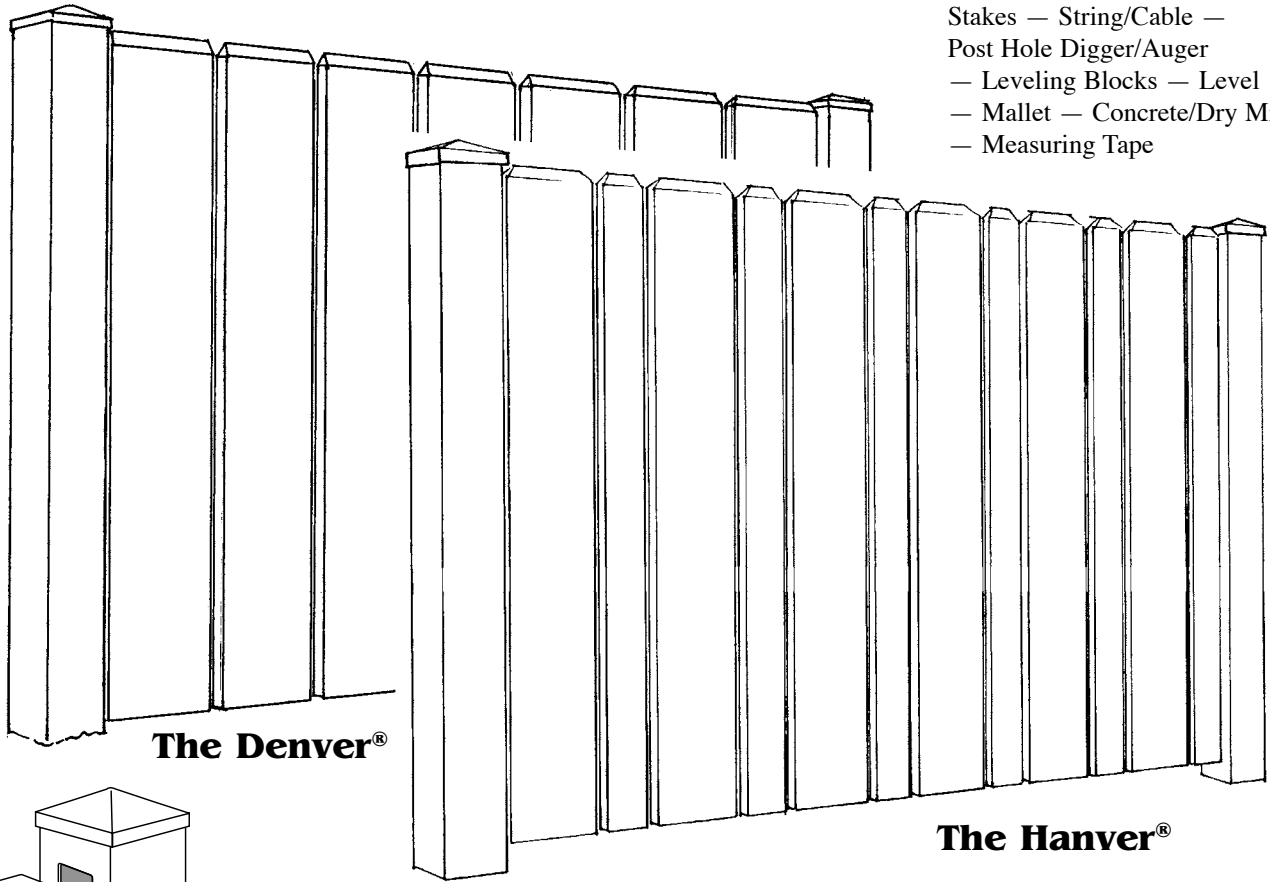

The Denver®

The Hanver®

Horizontals are pre-notched each end for insertion into routed holes.

Note: Once inserted it is difficult to remove horizontal.

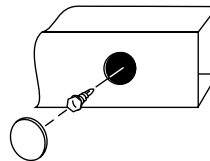

Verticals are secured to the horizontals with a No. 12 hex head screw. Capplugs cover the screw head on the horizontal.

STANDARD DENVER & HANVER DIMENSIONS

Standard Height Options:	48", 60", or 72"
Post Spacing Options: (Notice - Posts must be exactly centered to allow for expansion.)	4' or 6' center-to-center
Post Dimensions:	48" High Fence = 4" x 4" x 84" 60" High Fence = 4" x 4" x 96" 72" High Fence = 4" x 4" x 108"
Standard Post Depth: (Local conditions may require additional depth.)	48" High Fence = 36" Post Depth 60" High Fence = 36" Post Depth 72" High Fence = 36" Post Depth
Horizontal Dimensions:	3 1/2" Wide x 1 3/4" Thick
Denver Pickets (Verticals) 4' Post Spacing 6' Post Spacing Dimensions	17/64" Between Pickets 13/16" Between Pickets 6" Wide x 1" Thick
Hanver Pickets (Verticals) 4' Post Spacing 6' Post Spacing Dimensions	7/8" Between Pickets 1 5/64" Between Pickets 6" Wide x 1" Thick & 3" Wide x 7/8" Thick
Ground Clearance: (Grade variations will cause inconsistent ground clearance measurements.)	2"

The Georgetown®

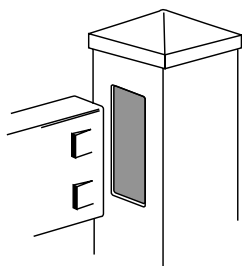
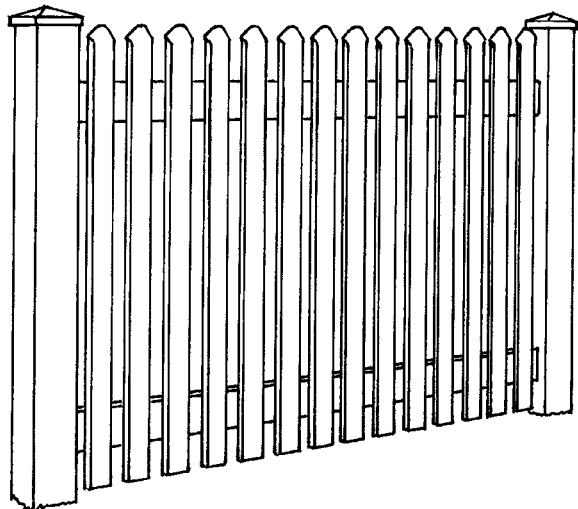

Horizontals are pre-notched each end for insertion into routed holes.

Note: Once inserted it is difficult to remove horizontal.

MATERIALS REQUIRED FOR INSTALLATION:
 Stakes — String/Cable — Radial Arm Saw/Hacksaw
 — Post Hole Digger/Auger — Leveling Blocks —
 5/16" Socket with Drill Extension — Drill/Speed Drill —
 Level — Mallet — Concrete/Dry Mix — Measuring Tape

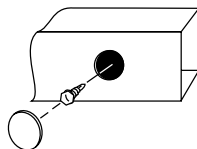

Verticals are secured to the horizontals with a No. 12 hex head screw. Capplugs cover the screw head on the horizontal.

The Nantucket™

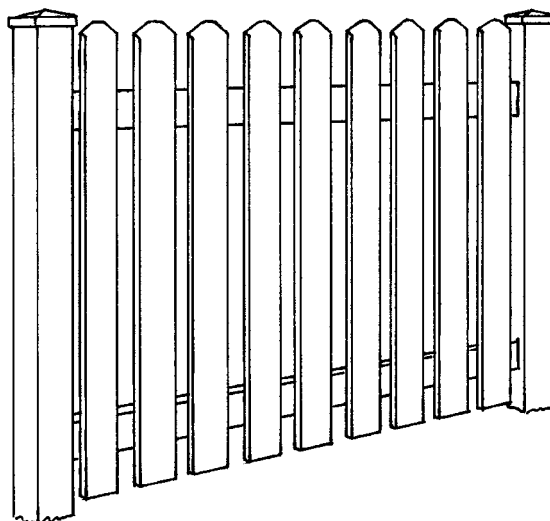

3 1/2" x 3 1/2" Corner Post

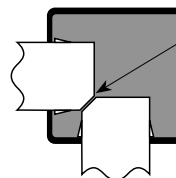

Trim off approximately 3/8" of the inside corner of the 1 3/4" x 3 1/2" horizontal

STANDARD GEORGETOWN DIMENSIONS

Standard Height Options:	36", 42", or 48"
Post Spacing Options: (Notice - Posts must be exactly centered to allow for expansion.)	4' or 6' center-to-center
Post Dimensions:	36" High Fence = 3 1/2" x 3 1/2" x 60" 42" High Fence = 3 1/2" x 3 1/2" x 66" 48" High Fence = 3 1/2" x 3 1/2" x 72"
Standard Post Depth: (Local conditions may require additional depth.)	36" High Fence = 24" Post Depth 42" High Fence = 24" Post Depth 48" High Fence = 24" Post Depth
Horizontal Dimensions:	3 1/2" Wide x 1 3/4" Thick
Pickets (Verticals)	Georgetown Spacing: 1 9/16" Between Pickets Nantucket Spacing: 1 3/4" Between Pickets
Picket Dimensions:	Picket Dimensions on Georgetown: 1 1/2" Wide x 3/4" Thick Picket Dimensions on Nantucket: 3" Wide x 7/8" Thick
Ground Clearance: (Grade variations will cause inconsistent ground clearance measurements.)	2"

The Hampton® (Straight, Scallop and Step Picket)

MATERIALS REQUIRED FOR INSTALLATION:

Stakes — String/Cable — Post Hole Digger/Auger — Leveling Blocks
— Level — Mallet — Concrete/Dry Mix — Measuring Tape

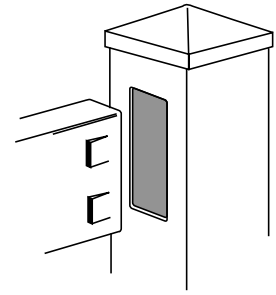

Horizontals are pre-notched each end for insertion into routed holes.

Note: Once inserted it is difficult to remove horizontal.

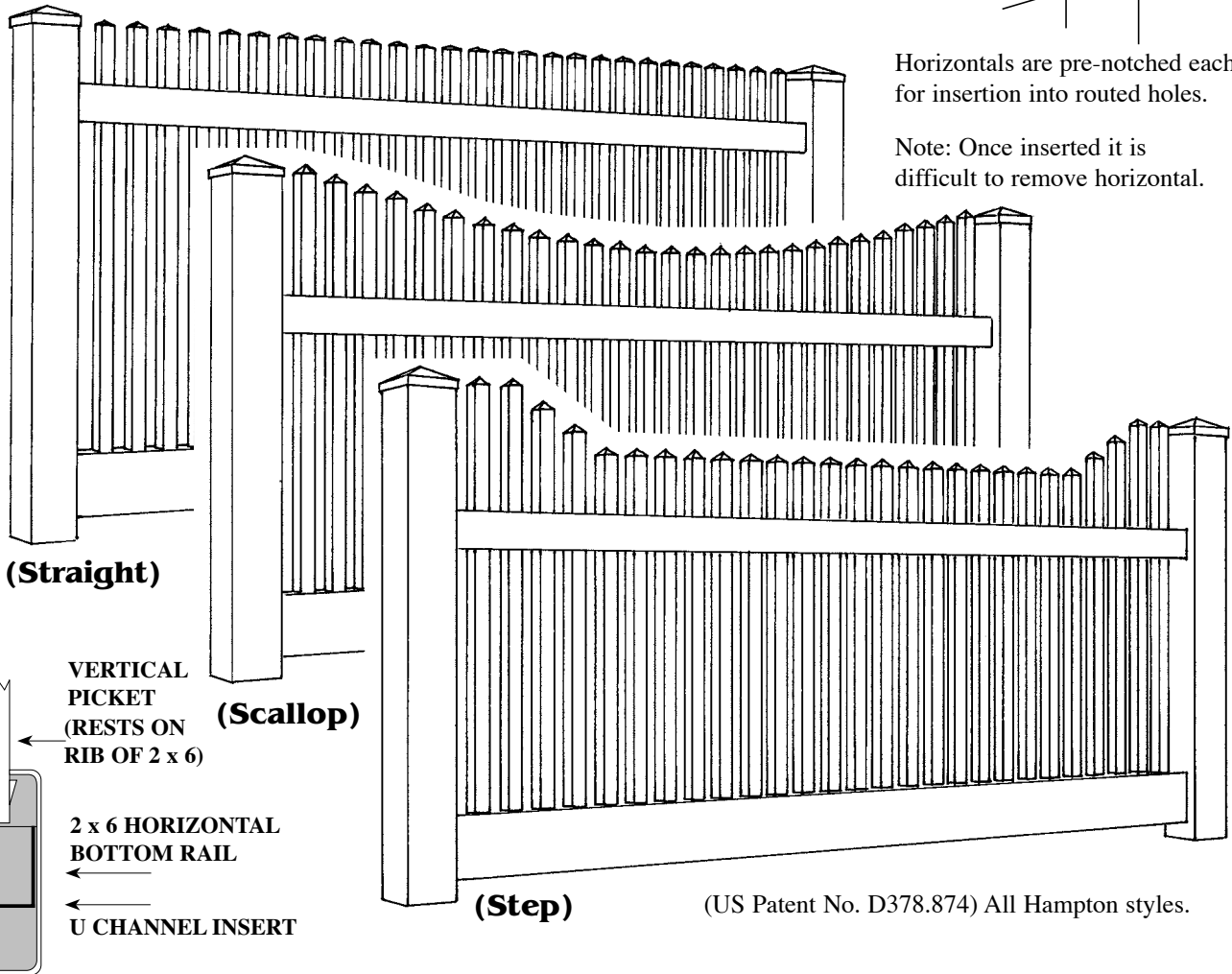

(Straight)

(Scallop)

(Step)

(US Patent No. D378.874) All Hampton styles.

VERTICAL PICKET
(RESTS ON RIB OF 2 x 6)

2 x 6 HORIZONTAL BOTTOM RAIL

U CHANNEL INSERT

STANDARD HAMPTON DIMENSIONS

Standard Height Options:	48", 60", or 72"
Post Spacing Options: (Notice - Posts must be exactly centered to allow for expansion.)	8' center-to-center
Post Dimensions:	48" High Fence = 5" x 5" x 72" 60" High Fence = 5" x 5" x 96" 72" High Fence = 5" x 5" x 108"
Standard Post Depth: (Local conditions may require additional depth.)	48" High Fence = 24" Post Depth 60" High Fence = 36" Post Depth 72" High Fence = 36" Post Depth
Horizontal Dimensions:	3 1/2" Wide x 2" Thick (Top) 6" Wide x 2" Thick (Bottom)
Pickets (Verticals) Picket Dimensions	1 7/8" Between Pickets 1 1/2" Wide x 1 1/2" Thick
Ground Clearance: (Grade variations will cause inconsistent ground clearance measurements.)	2"

The Hannibal®

MATERIALS REQUIRED FOR INSTALLATION:
 Stakes — String/Cable — Radial Arm Saw/Hacksaw
 — Post Hole Digger/Auger — Leveling Blocks — 5/16" Socket with Drill Extension — Drill/Speed Drill — Level
 — Mallet — Concrete/Dry Mix — Measuring Tape

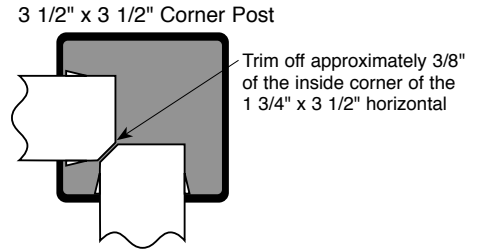
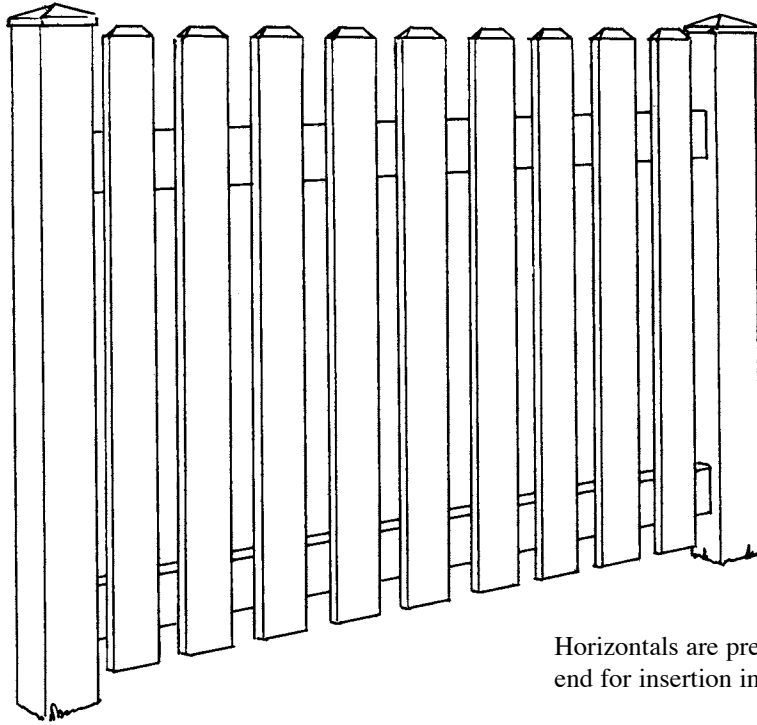

Horizontals are pre-notched each end for insertion into routed holes.

Note: Once inserted it is difficult to remove horizontal.

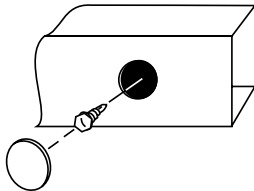
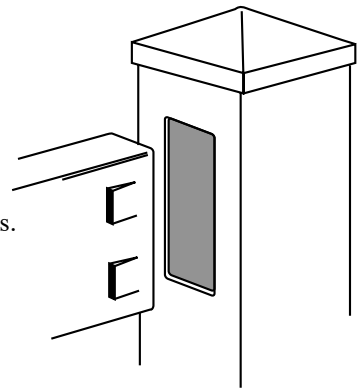

Verticals are secured to the horizontals with a No. 12 hex head screw. Caplugs cover the screw head on the horizontal.

STANDARD HANNIBAL DIMENSIONS

Standard Height Options:	36", 42", or 48"
Post Spacing Options: (Notice - Posts must be exactly centered to allow for expansion.)	4' or 6' center-to-center
Post Dimensions:	36" High Fence = 3 1/2" x 3 1/2" x 60" 42" High Fence = 3 1/2" x 3 1/2" x 66" 48" High Fence = 3 1/2" x 3 1/2" x 72"
Standard Post Depth: (Local conditions may require additional depth.)	36" High Fence = 24" Post Depth 42" High Fence = 24" Post Depth 48" High Fence = 24" Post Depth
Horizontal Dimensions:	3 1/2" Wide x 1 3/4" Thick
Pickets (Verticals) Picket Dimensions:	1 3/4" Between Pickets 3" Wide x 7/8" Thick
Ground Clearance: (Grade variations will cause inconsistent ground clearance measurements.)	2"

The Kensington®

MATERIALS REQUIRED FOR INSTALLATION:

Stakes — String/Cable — Post Hole Digger/Auger — Leveling
 Blocks — Level — Mallet — Concrete/Dry Mix — Measuring Tape

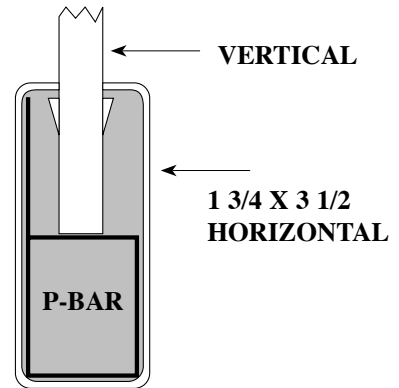
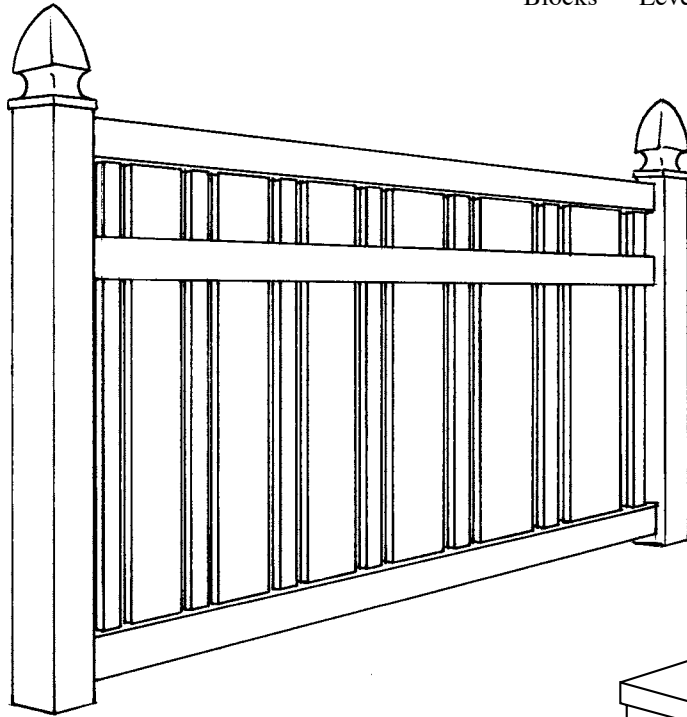

Horizontals are pre-notched each end for insertion into routed holes.

Note: Once inserted it is difficult to remove horizontal.

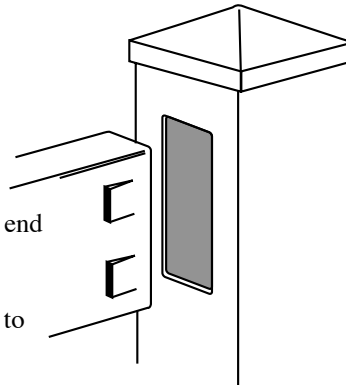

STANDARD KENSINGTON DIMENSIONS

Standard Height Options:	48", 60", or 72"
Post Spacing Options: (Notice - Posts must be exactly centered to allow for expansion.)	6' or 8' center-to-center
Post Dimensions:	48" High Fence = 4" x 4" x 72" 60" High Fence = 4" x 4" x 96" 72" High Fence = 4" x 4" x 108"
Standard Post Depth: (Local conditions may require additional depth.)	48" High Fence = 24" Post Depth 60" High Fence = 36" Post Depth 72" High Fence = 36" Post Depth
Horizontal Dimensions:	3 1/2" Wide x 1 3/4" Thick
Pickets (Verticals) 6' Post Spacing 8' Post Spacing Dimensions	1 1/4" Between Pickets 1 1/2" Between Pickets 6" Wide x 1" Thick and 2" Wide x 1" Thick
Ground Clearance: (Grade variations will cause inconsistent ground clearance measurements.)	2"

The Lakeland® (Convex, Concave, Heavy Duty) — The Hollingsworth™

MATERIALS REQUIRED FOR INSTALLATION: Stakes — String/Cable — Post Hole Digger/Auger —
Leveling Blocks — Level — Mallet — Concrete/Dry Mix — Measuring Tape

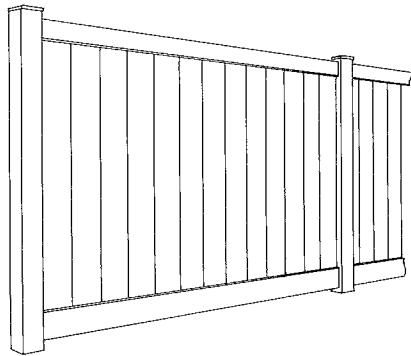

The Lakeland®

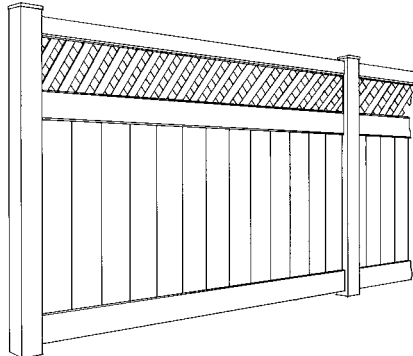

The Hollingsworth™

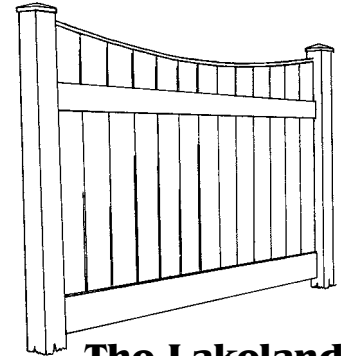

**The Lakeland®
Concave**

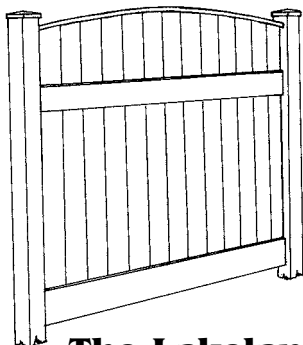

**The Lakeland®
Convex**

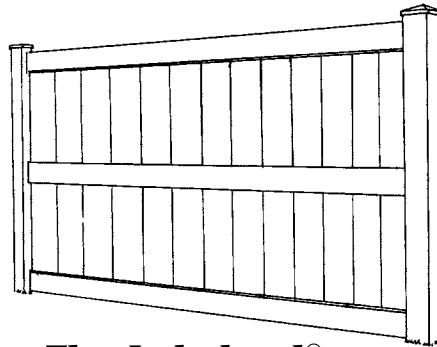

**The Lakeland®
Heavy Duty**

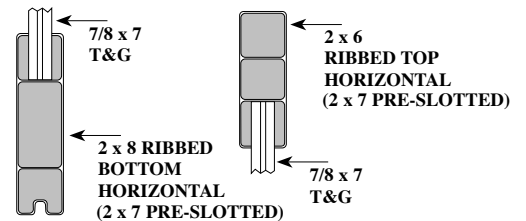

Horizontals are pre-notched each end for insertion into routed holes.

Note: Once inserted it is difficult to remove horizontal.

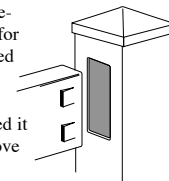

STANDARD LAKELAND & HOLLINGSWORTH DIMENSIONS

Standard Height Options:	48", 60", or 72" *Heavy Duty only available in 6' high
Post Spacing Options: (Notice - Posts must be exactly centered to allow for expansion.)	8' center-to-center
Post Dimensions:	48" High Fence = 5" x 5" x 84" (.135 wall) 60" High Fence = 5" x 5" x 96" (.135 wall) 72" High Fence = 5" x 5" x 108" (.135 wall) *Heavy Wall 5" x 5" x 108" (.270 wall)
Standard Post Depth: (Local conditions may require additional depth.)	48" High Fence = 34" Post Depth 60" High Fence = 34" Post Depth 72" High Fence = 34" Post Depth 2" Wide x 1" Thick Capstock
Horizontal Dimensions:	8" Wide x 2" Thick (Bottom) 6" Wide x 2" Thick (Top/Middle) 3 1/2" Wide x 2" Thick (Top - Hollingsworth only)
Pickets Dimensions (Verticals) (For additional strength, these verticals are tongue and groove. The width is 7" plus the tongue.)	7" Wide x 7/8" Thick
Ground Clearance: (Grade variations will cause inconsistent ground clearance measurements.)	2"

The Lincolnshire®

MATERIALS REQUIRED FOR INSTALLATION:
 Stakes — String/Cable — Post Hole Digger/Auger
 — Leveling Blocks — Level — Mallet — Concrete/
 Dry Mix — Measuring Tape

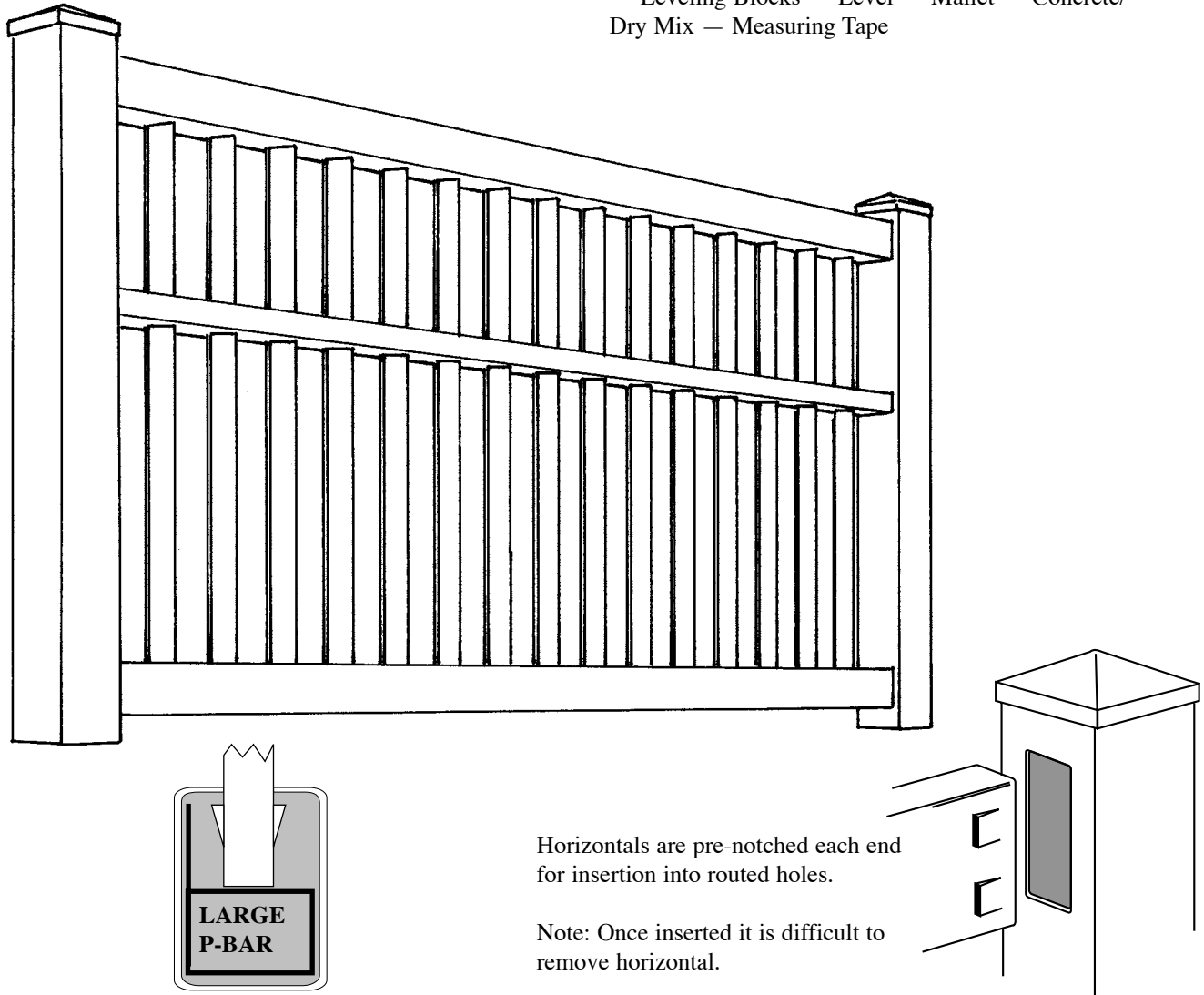

Horizontals are pre-notched each end for insertion into routed holes.

Note: Once inserted it is difficult to remove horizontal.

STANDARD LINCOLNSHIRE DIMENSIONS	Standard Height Options:	48", 60", or 72"
	Post Spacing Options: <small>(Notice - Posts must be exactly centered to allow for expansion.)</small>	8' center-to-center
	Post Dimensions:	48" High Fence = 5" x 5" x 72" 60" High Fence = 5" x 5" x 96" 72" High Fence = 5" x 5" x 108"
	Standard Post Depth: <small>(Local conditions may require additional depth.)</small>	48" High Fence = 22" Post Depth 60" High Fence = 34" Post Depth 72" High Fence = 34" Post Depth
	Horizontal Dimensions:	3 1/2" Wide x 3 1/2" Thick (Top & Bottom) 1 3/4" Wide x 3 1/2" Thick (Middle)
	Pickets (Verticals) Picket Dimensions	3" Between Pickets 1 1/2" Wide x 1 1/2" Thick
	Ground Clearance: <small>(Grade variations will cause inconsistent ground clearance measurements.)</small>	2"

The Malibu®

MATERIALS REQUIRED FOR INSTALLATION:
 Stakes — String/Cable — Post Hole Digger/Auger — Leveling
 Blocks — Level — Mallet — Concrete/Dry Mix — Measuring Tape

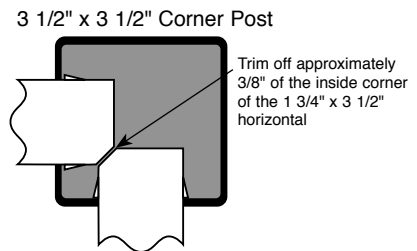
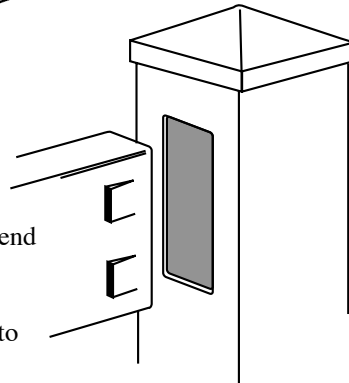
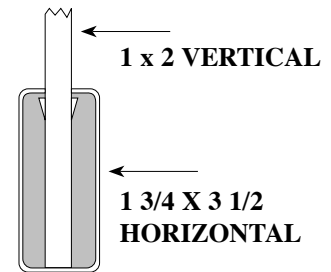
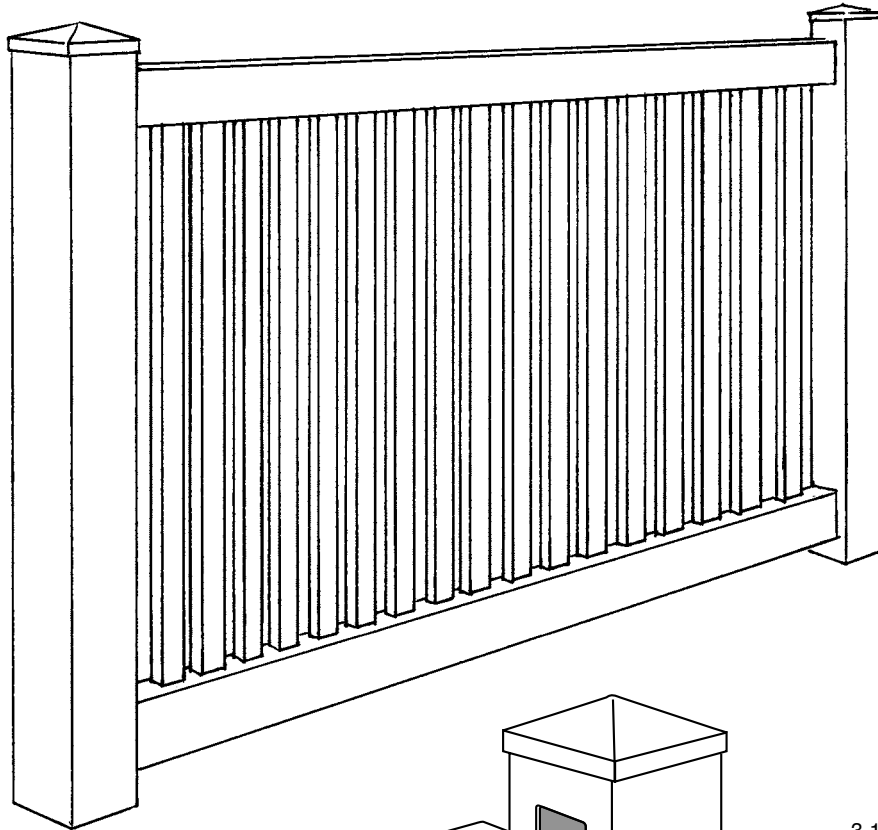

Horizontals are pre-notched each end for insertion into routed holes.

Note: Once inserted it is difficult to remove horizontal.

**STANDARD
MALIBU DIMENSIONS**

Standard Height Options:	36", 42", or 48"
Post Spacing Options: (Notice - Posts must be exactly centered to allow for expansion.)	4' or 6' center-to-center
Post Dimensions:	36" High Fence = 3 1/2" x 3 1/2" x 60" 42" High Fence = 3 1/2" x 3 1/2" x 66" 48" High Fence = 3 1/2" x 3 1/2" x 72"
Standard Post Depth: (Local conditions may require additional depth.)	36" High Fence = 22" Post Depth 42" High Fence = 22" Post Depth 48" High Fence = 22" Post Depth
Horizontal Dimensions:	3 1/2" Wide x 1 3/4" Thick
Pickets (Verticals) 4' Post Spacing 6' Post Spacing Picket Dimensions	1 15/16" Between Pickets 1 15/16" Between Pickets 2" Wide x 1" Thick
Ground Clearance: (Grade variations will cause inconsistent ground clearance measurements.)	2"

The Montauk™ & The Montauk Point™

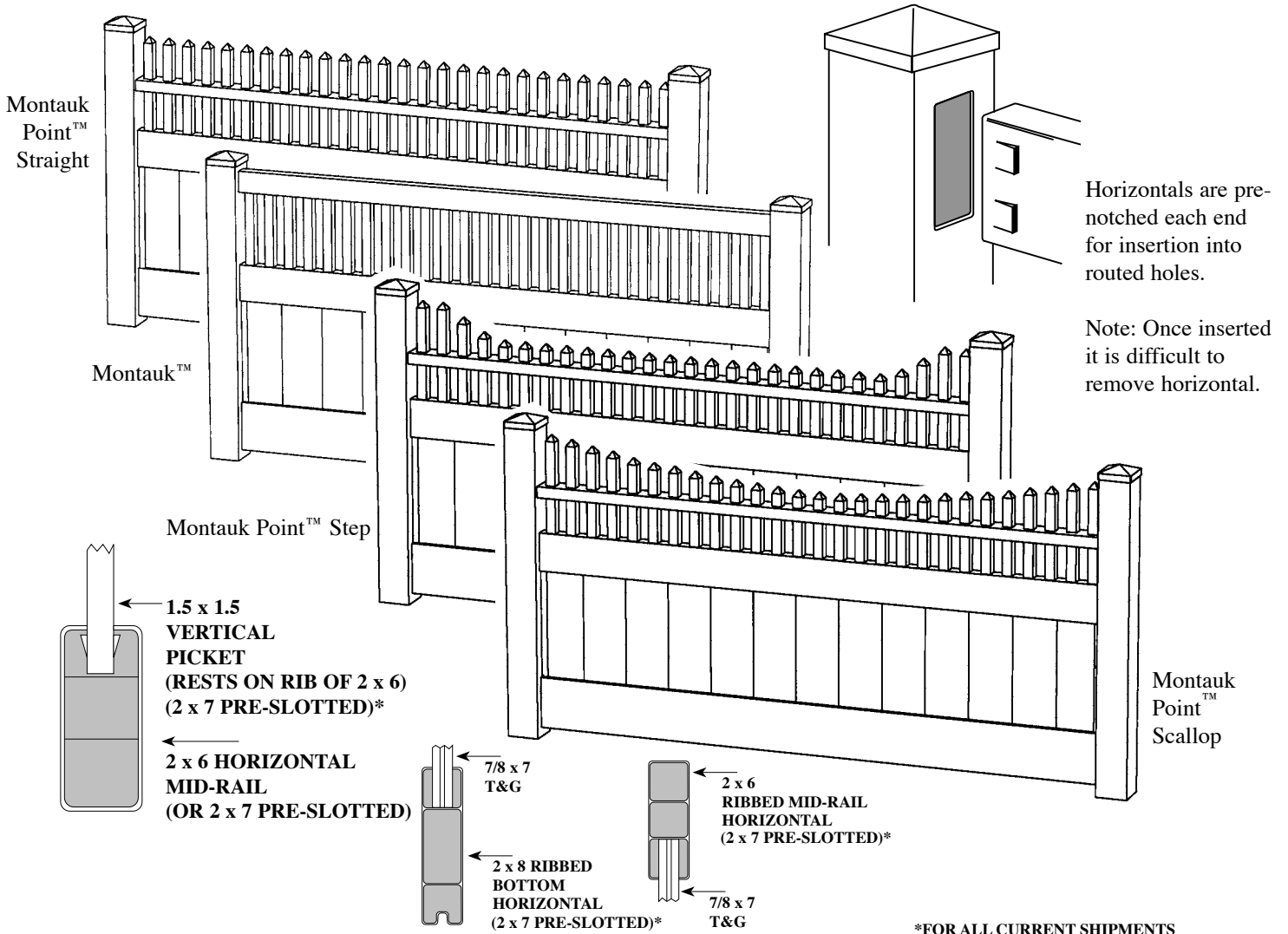

*FOR ALL CURRENT SHIPMENTS

**STANDARD
MONTAUK DIMENSIONS**

Standard Height Options:	48", 60", or 72"
Post Spacing Options: (Notice - Posts must be exactly centered to allow for expansion.)	8' center-to-center
Post Dimensions:	48" High Fence = 5" x 5" x 84" 60" High Fence = 5" x 5" x 96" 72" High Fence = 5" x 5" x 108"
Standard Post Depth: (Local conditions may require additional depth.)	48" High Fence = 36" Post Depth 60" High Fence = 36" Post Depth 72" High Fence = 36" Post Depth
Standard Post Cap:	5" x 5" Traditional (External Flange)
Horizontal Dimensions:	2" Thick x 8" Wide (Bottom) 2" Thick x 6" Wide (Middle) 2" Thick x 3 1/2" Wide (Top - Montauk only) 1 3/4" Thick x 3 1/2" Wide (Top - Montauk Point Straight, Scallop, and Step)
Picket Dimensions (Verticals):	7/8" Thick x 7" Wide (Bottom) 1 1/2" Thick x 1 1/2" Wide (Top)
Ground Clearance: (Grade variations will cause inconsistent ground clearance measurements.)	2"

The Marseille®

MATERIALS REQUIRED FOR INSTALLATION:
 Stakes — String/Cable — Post Hole Digger/Auger — Leveling
 Blocks — 5/16" Socket with Drill Extension — Drill/Speed Drill
 — Level — Mallet — Concrete/Dry Mix — Measuring Tape

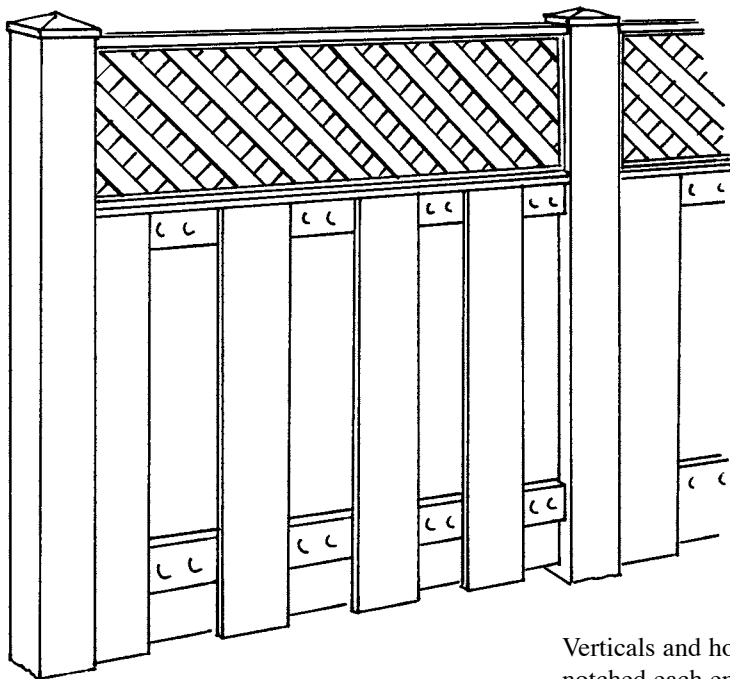

Verticals and horizontals are pre-notched each end for insertion into routed holes.

Note: Once inserted it is difficult to remove horizontal/vertical.

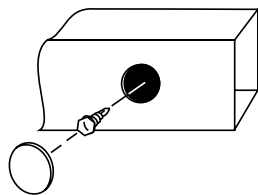
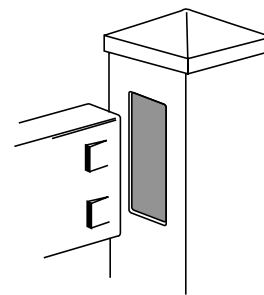

Verticals are secured to the horizontals with a No. 12 hex head screw. Capplugs cover the screw head on the horizontal.

**STANDARD
MARSEILLE DIMENSIONS**

Standard Height Options:	48", 60", or 72"
Post Spacing Options: (Notice - Posts must be exactly centered to allow for expansion.)	4' or 6' center-to-center
Post Dimensions:	48" High Fence = 5" x 5" x 84" 60" High Fence = 5" x 5" x 96" 72" High Fence = 5" x 5" x 108"
Standard Post Depth: (Local conditions may require additional depth.)	48" High Fence = 36" Post Depth 60" High Fence = 36" Post Depth 72" High Fence = 36" Post Depth
Horizontal Dimensions:	3 1/2" Wide x 1 3/4" Thick
Pickets Dimensions (Verticals)	6" Wide x 1" Thick
Ground Clearance: (Grade variations will cause inconsistent ground clearance measurements.)	2"

The Melbourne® (and Melbourne w/Lattice)

MATERIALS REQUIRED FOR INSTALLATION:
Stakes — String/Cable — Post Hole Digger/Auger
— Leveling Blocks — Level — Mallet — Concrete/
Dry Mix — Measuring Tape

The Melbourne®

The Melbourne® with Lattice

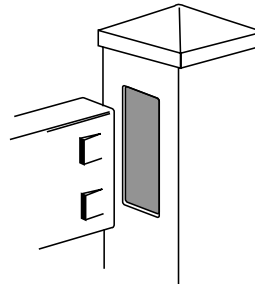
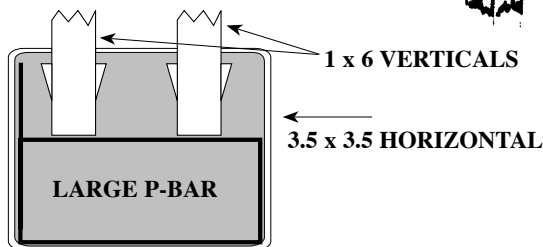
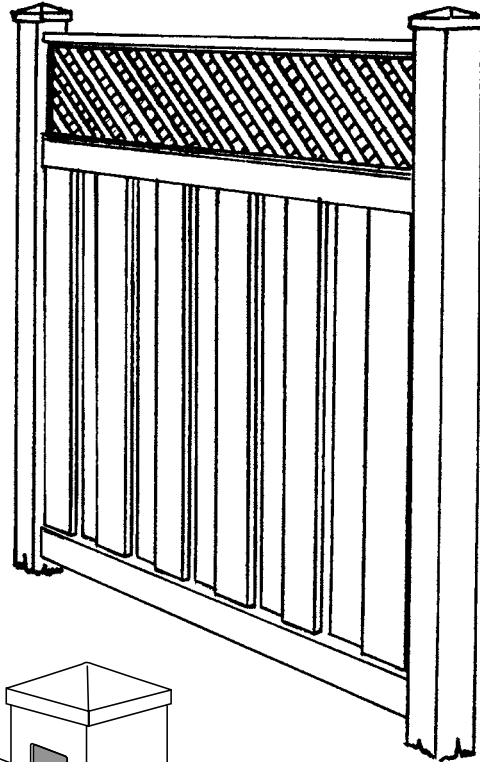
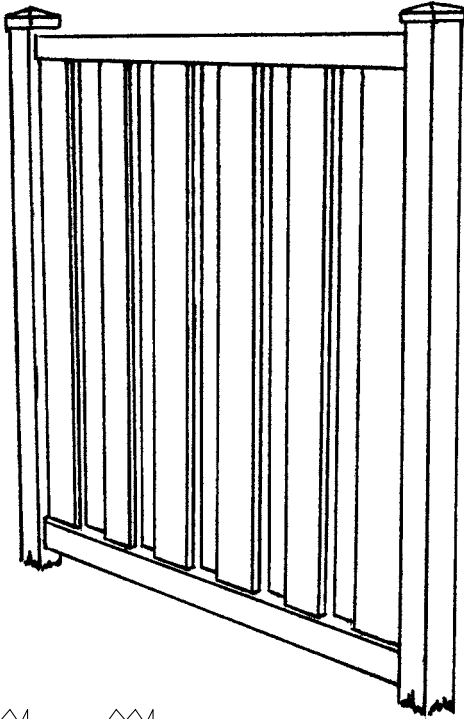

Horizontals are pre-notched each end for insertion into routed holes.

Note: Once inserted it is difficult to remove horizontal.

**STANDARD
MELBOURNE DIMENSIONS**

Standard Height Options:	48", 60", or 72"
Post Spacing Options: (Notice - Posts must be exactly centered to allow for expansion.)	8' center-to-center
Post Dimensions:	48" High Fence = 5" x 5" x 72" 60" High Fence = 5" x 5" x 96" 72" High Fence = 5" x 5" x 108"
Standard Post Depth: (Local conditions may require additional depth.)	48" High Fence = 22" Post Depth 60" High Fence = 34" Post Depth 72" High Fence = 34" Post Depth
Horizontal Dimensions:	3 1/2" Wide x 3 1/2" Thick
Pickets (Verticals) Picket Dimensions	5 3/8" Between Pickets 6" Wide x 1" Thick
Ground Clearance: (Grade variations will cause inconsistent ground clearance measurements.)	2"

The Rochester™

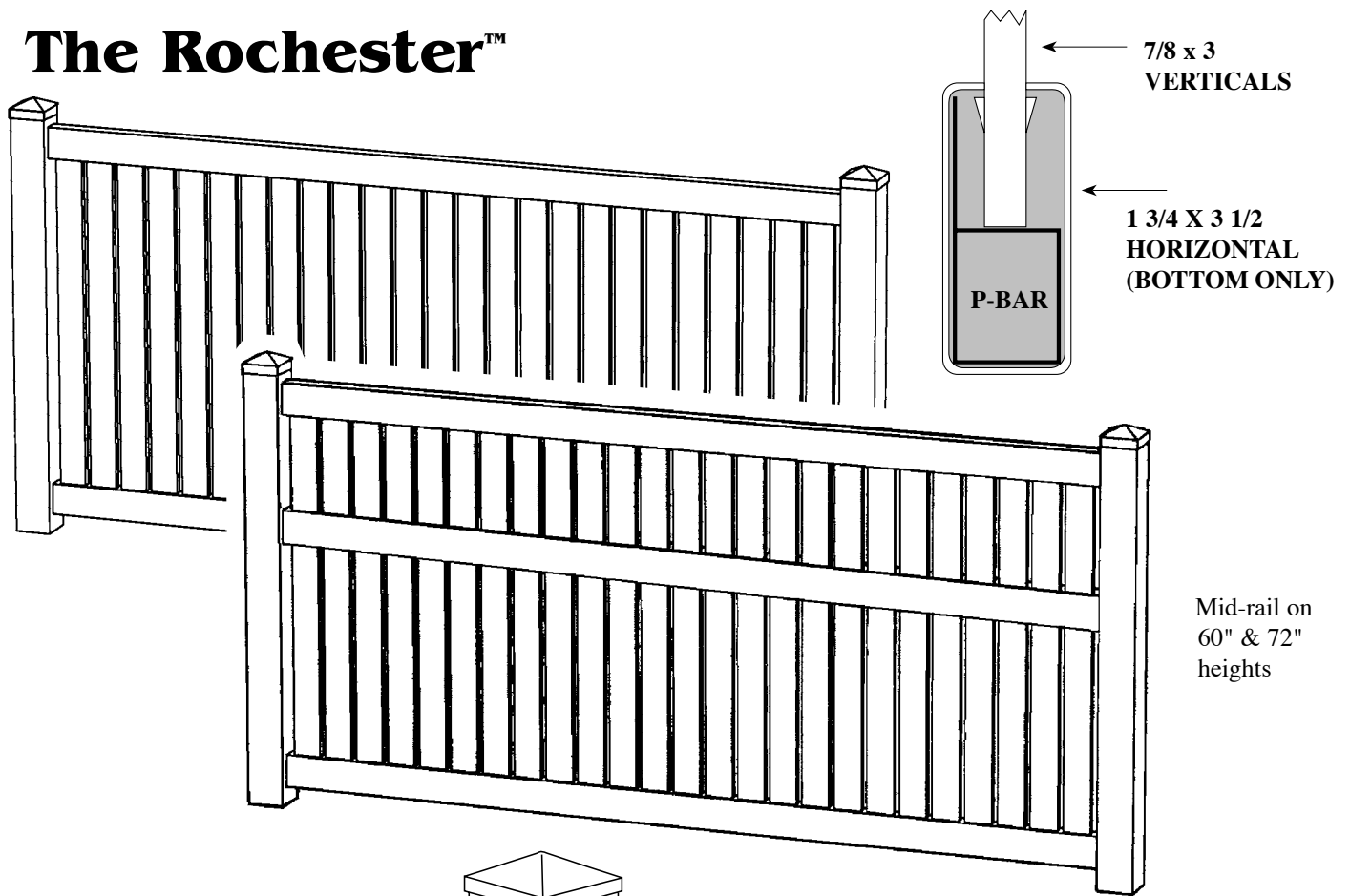

Mid-rail on
60" & 72"
heights

Horizontals are pre-notched each end for insertion into routed holes.

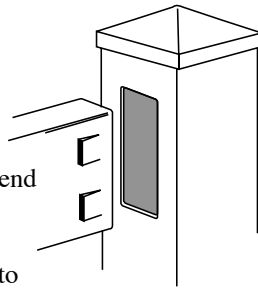

Note: Once inserted it is difficult to remove horizontal.

STANDARD ROCHESTER DIMENSIONS

Standard Height Options:	48", 60", or 72"
Post Spacing Options: (Notice - Posts must be exactly centered to allow for expansion.)	8' center-to-center
Post Dimensions:	48" High Fence = 4" x 4" x 72" 60" High Fence = 4" x 4" x 96" 72" High Fence = 4" x 4" x 108"
Standard Post Depth: (Local conditions may require additional depth.)	48" High Fence = 24" Post Depth 60" High Fence = 36" Post Depth 72" High Fence = 36" Post Depth
Standard Post Cap:	4" x 4" Traditional (External Flange)
Horizontal Dimensions:	1 3/4" Thick x 3 1/2" Wide (Top, Mid & Bottom Rails)
Picket Dimensions (Verticals)	7/8" Thick x 3" Wide
Ground Clearance: (Grade variations will cause inconsistent ground clearance measurements.)	2"

The Springfield®

MATERIALS REQUIRED FOR INSTALLATION:

Stakes — String/Cable — Post Hole Digger/Auger — Leveling Blocks — Level — Mallet — Concrete/Dry Mix — Measuring Tape

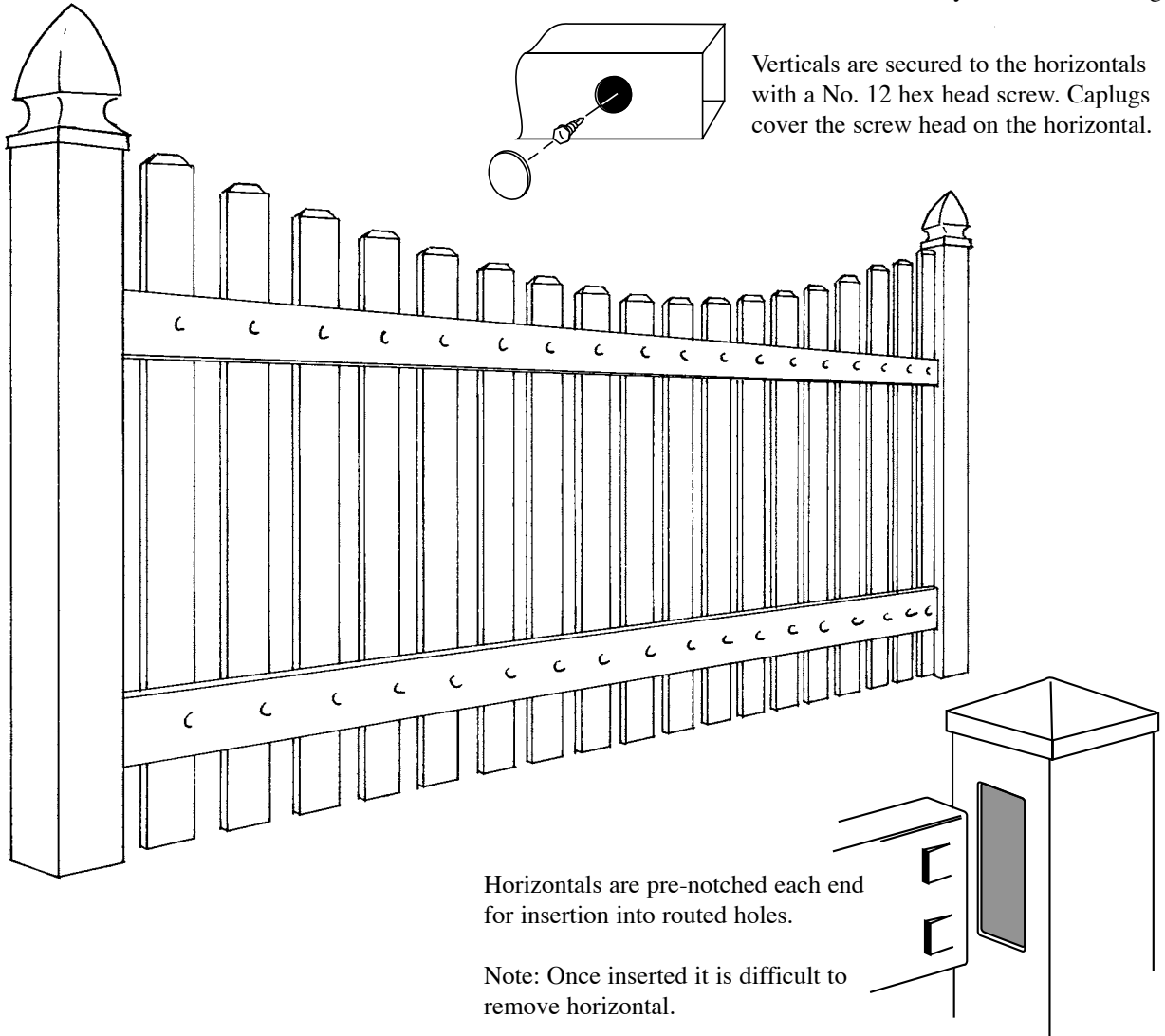

Verticals are secured to the horizontals with a No. 12 hex head screw. Capplugs cover the screw head on the horizontal.

Horizontals are pre-notched each end for insertion into routed holes.

Note: Once inserted it is difficult to remove horizontal.

STANDARD SPRINGFIELD DIMENSIONS

Standard Height Options:	48", 60", or 72"
Post Spacing Options: (Notice - Posts must be exactly centered to allow for expansion.)	8' center-to-center
Post Dimensions:	48" High Fence = 5" x 5" x 72" 60" High Fence = 5" x 5" x 96" 72" High Fence = 5" x 5" x 108"
Standard Post Depth: (Local conditions may require additional depth.)	48" High Fence = 24" Post Depth 60" High Fence = 36" Post Depth 72" High Fence = 36" Post Depth
Horizontal Dimensions:	5 1/2" Wide x 1 1/2" Thick
Pickets (Verticals) Picket Dimensions	2" Between Pickets 3" Wide x 7/8" Thick
Ground Clearance: (Grade variations will cause inconsistent ground clearance measurements.)	2"

The Windsor®

MATERIALS REQUIRED FOR INSTALLATION:
 Stakes — String/Cable — Post Hole Digger/Auger
 — Leveling Blocks — Level — Mallet — Concrete/Dry
 Mix — Measuring Tape

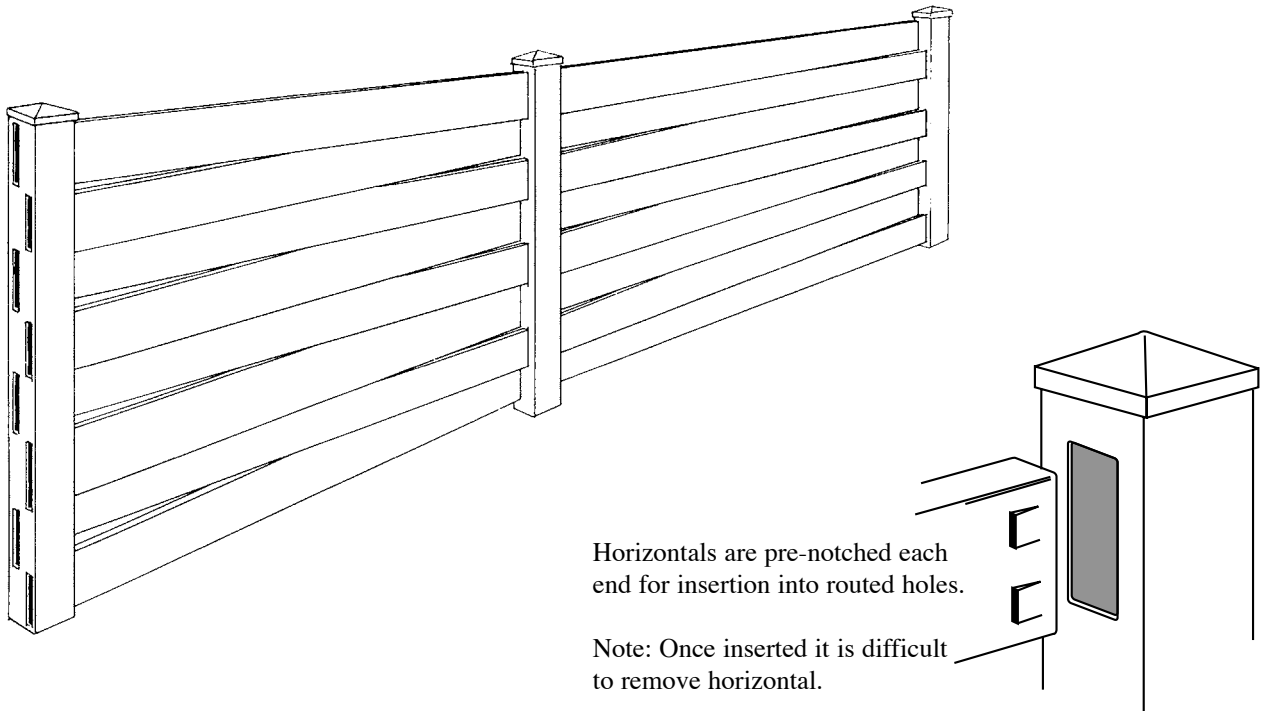

Horizontals are pre-notched each end for insertion into routed holes.

Note: Once inserted it is difficult to remove horizontal.

STANDARD WINDSOR DIMENSIONS	Standard Height Options:	48", 60", or 72"
	Post Spacing Options: <i>(Notice - Posts must be exactly centered to allow for expansion.)</i>	8' center-to-center
	Post Dimensions:	48" High Fence = 5" x 5" x 84" 60" High Fence = 5" x 5" x 96" 72" High Fence = 5" x 5" x 108" (heavy wall)
	Standard Post Depth: <i>(Local conditions may require additional depth.)</i>	48" High Fence = 36" Post Depth 60" High Fence = 36" Post Depth 72" High Fence = 36" Post Depth
	Horizontal Dimensions	6" Wide x 1" Thick
	Ground Clearance: <i>(Grade variations will cause inconsistent ground clearance measurements.)</i>	2"

Country Estate® installation practices and recommendations does not purport to address all of the safety concerns and/or local code requirements, associated with it's use. It is the responsibility of the user of these prescribed installation practices to establish appropriate safety, health, and installation practices and determine the applicability of regulatory limitations prior to use.

Safety — All work shall be performed in safe and orderly fashion in accordance with the Williams-Steiger Occupational Safety and Health Act of 1970.

Country Estate 3-Rail



The Georgetown®

COUNTRY®
ESTATE
FENCE

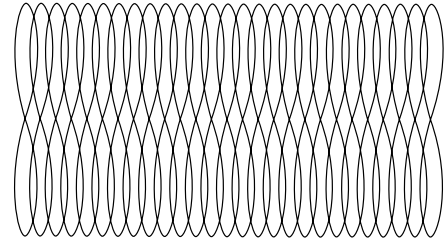
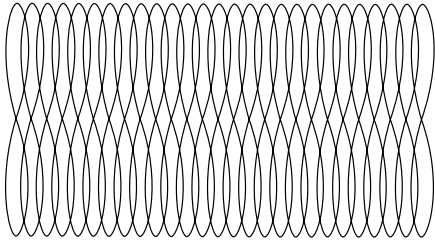

Nebraska Plastics, Inc. warrants that it will provide the original consumer purchaser of PVC Country Estate Fence, Deck, Railing and Country Manor Garden Accessories with products that are free from defective raw materials and manufacturing defects. As a result, these products will not peel, flake, rust, blister or corrode. Furthermore, Nebraska Plastics, Inc. warrants that these products will not require the painting and traditional maintenance normally associated with fencing manufactured from raw materials other than PVC, nor will they exhibit abnormal weathering, discoloration and brittleness, nor will they be damaged by insects.

What materials are covered by this warranty?

- All PVC products manufactured and sold as Country Estate Fence, Deck Railing and Country Manor Garden Accessories are covered by this 50-year warranty if the original consumer purchaser registers his/her warranty with Nebraska Plastics within 30 days of his/her purchase. Products sold by Nebraska Plastics, Inc. but not manufactured of PVC are not covered by this warranty.

What does this warranty cover?

- Product failure resulting from defective raw materials and/or manufacturing defects.

How long will the warranty be effective?

- For residential consumer purchases, the warranty shall be fully effective without proration for fifty years from the date of purchase or until the original consumer purchaser sells his property without effecting a properly executed warranty transfer or until the warranted materials are moved from their original location and/or altered from their original Country Estate approved designs. No combination of events will extend the warranty beyond fifty years from the original residential consumer's purchase.
- For commercial purchases, the warranty shall be effective without proration for twenty years from the date of purchase or until the original commercial property owner sells the property or until the warranted materials are moved from their original location and/or altered from their original Country Estate approved designs. Warranties on commercial purchase are not transferable.

Are registered Country Estate and Country Manor warranties transferable?

- Properly registered Country Estate and/or Country Manor warranties are eligible for a one-time transfer by the original residential consumer owner to a subsequent residential consumer purchaser of the real estate on which the warranted products were originally installed if:
 1. The warranty to be transferred was properly registered with Nebraska Plastics, Inc. within 30 days after the original purchase.
 2. The request for transfer is made within ten years of the original purchase.
 3. The product has not been moved from its original location and/or altered from its original Country Estate approved design or modified in any manner that compromises the product's original integrity.
 4. Nebraska Plastics, Inc. receives a written request for transfer within 30 days of the real estate transfer.
 5. Nebraska Plastics, Inc. receives proof of the original purchase and receives a copy of the original warranty that was signed by the Authorized Independent Country Estate Dealer/Installer establishing that the installation is 100% Country Estate products.
 6. Nebraska Plastics, Inc. receives a \$25 processing fee paid in full prior to the transfer.
 7. Warranties on commercial purchases are not transferable.

NOTICE: A TRANSFER OF THE WARRANTY WILL NOT EXTEND THE OVERALL WARRANTY PERIOD BEYOND 50 YEARS FROM THE ORIGINAL PURCHASE DATE.

What will Nebraska Plastics, Inc. do if problems develop?

- Nebraska Plastics, Inc. will furnish the registered owner of record with materials that are not defective.

How does the owner of record obtain warranty replacement materials?

- Contact the dealer who sold and/or installed the Country Estate Fence, Deck, Railing and/or Country Manor Products or write to Nebraska Plastics, Inc., P. O. Box 45, Cozad, Nebraska 69130 or call Nebraska Plastics, Inc. at 1-800-445-2887.

What is not covered by this warranty?

- Compensation other than being furnished replacement materials.
- Compensation for defective fabrication and/or installation work not performed by Nebraska Plastics, Inc. employees. The Authorized Independent Country Estate Installer must provide the warranty covering his/her fabrication and installation work. (On request, Nebraska Plastics, Inc. will provide the installer

and the consumer purchaser with installation manuals that describe recommended installation procedures or installation instructions and recommendations may be found at www.countryestate.com.)

- Compensation relating to projects where PVC materials manufactured by companies other than Nebraska Plastics, Inc. have been combined with Nebraska Plastics, Inc. PVC.
- Compensation for removing materials and/or mildew applied and/or accumulated on the products after the product was manufactured.
- Compensation for Hardware or other non-PVC items replacement or removal.
- Compensation for damage due to misuse, vandalism, accidents or acts of God.
- Compensation for an insurable loss.
- Compensation for Country Estate Fence, Deck, Railing and/or Country Manor products that have been combined or incorporated into structures other than those manufactured by Nebraska Plastics, Inc. or that have been altered by the addition of paints and/or chemicals not recommended for use with Polyvinyl Chloride (PVC).
- Movement, distortion, collapse or settling of the ground or structure on which the fence, deck or railing is installed.
- Any other cause of failure not involving material and/or manufacturing defects in the product.
- Recoveries for consequential or incidental damages.
- Compensation for Country Estate Fence, Deck, Railing and/or Country Manor products for discoloration or other damage caused by air pollution (including but not limited to metal oxides or metallic particles), exposure to harmful chemicals or normal weathering from the elements.
- Compensation for normal and expected weathering. (Normal weathering shall be defined as exposure to ultra-violet light and extremes of weather and atmospheric conditions that will cause any colored surfaces to experience changes within the weather and color hold standards established in ASTM Specification D-4726.

Other considerations limiting a purchaser's rights under this warranty:

- Nebraska Plastics shall have sole discretion to determine, based on reasonable criteria, whether the Country Estate Fence, Deck or Railing and/or Country Manor Products exhibit abnormal weathering. If the fence, deck or railing weathers to a degree determined by Nebraska Plastics to be beyond normal, Nebraska Plastics will, at its option, make repairs it deems appropriate or provide replacement material as it deems appropriate. Nebraska Plastics also reserves the right to refund the amount paid by the original owner for the Country Estate Fence, Deck or Railing and/or Country Manor Products materials and accessories.
- Nebraska Plastics retains the right to discontinue or modify any of its products, including the color, without notice to the homeowner/consumer, nor shall Nebraska Plastics be liable in the event the replacement material may vary in color or gloss in comparison to the original product as a result of normal weathering. If Nebraska Plastics replaces any material under this warranty, it may substitute products designated by Nebraska Plastics to be of comparable quality or price range in the event the product initially installed has been discontinued or modified.
- All disputes shall be governed by Nebraska law.

How does state law relate to this warranty?

- You may have rights other than those specified in this warranty. These rights vary from state to state.

How do you preserve your rights as a purchaser of Country Estate Products?

- On completion of your Country Estate project, your Authorized Independent Country Estate dealer should provide an official copy of the warranty that includes a registration card that must be signed by the Authorized Independent Country Estate Dealer/Installer and that card must be returned to Nebraska Plastics, Inc. If your dealer does not provide a copy of the warranty, call 1-800-445-2887.

Nebraska Plastics, Inc. will acknowledge receipt of your warranty registration.