

Wood Fence Hardware

- Hinges
- Latches
- Drop Rods
- Handles
- Accessories



Wood Fence Rustic Series and Hammered Bronze

Nationwide Industries Rustic Series

12", 16", 20" and 24" Hinges

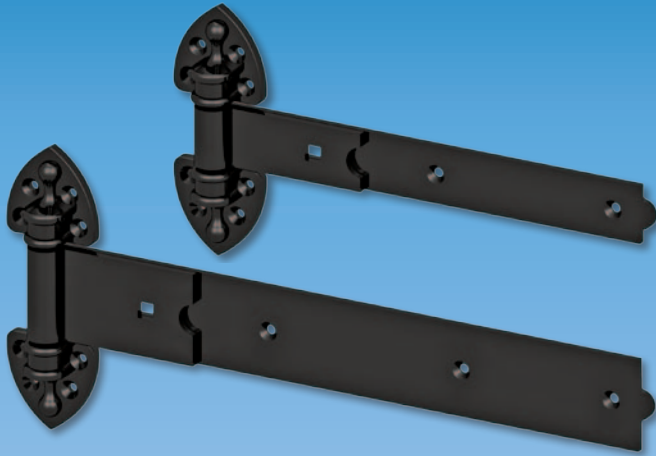

RUSH112-BK

- ▶ 12" pair of black hinges
- ▶ 1/2" pin
- ▶ Powder coated finish
- ▶ 10 pair per case @ 59 lbs

RUSH116-BK

- ▶ 16" pair of black hinges
- ▶ 1/2" pin
- ▶ Powder coated finish
- ▶ 8 pair per case @ 50 lbs

RUSH220-BK

- ▶ 20" pair of black hinges
- ▶ 5/8" pin
- ▶ Powder coated finish
- ▶ 6 pair per case @ 55 lbs

RUSH224-BK

- ▶ 24" pair of black hinges
- ▶ 5/8" pin
- ▶ Powder coated finish
- ▶ 4 pair per case @ 45 lbs

* All hinges include stainless steel screws and a **carriage bolt** with painted head

Twisted Ring Latch



RUSL1-BK

- ▶ Operates from either side
- ▶ Fits gates up to 5" thick
- ▶ Powder coated finish
- ▶ 10 per case @ 20 lbs

Hinges:

NW38937Q-HBZ

- ▶ See NW38937Q on page 2

NW38945Q-HBZ

- ▶ See NW38945Q on page 2

NW38944Q-HBZ

- ▶ See NW38944Q on page 4

Latches:

NW38308Q-HBZ

- ▶ See NW38308Q on page 7

NW38310Q-HBZ

- ▶ See NW38310Q on page 7

NW38307-HBZ

- ▶ See NW38307 on page 7

Hammered Bronze Hinges, Latches, Kits, Drop Rods and Handles

Improve the look and value of your whole fence
by upgrading the finish on your hardware!

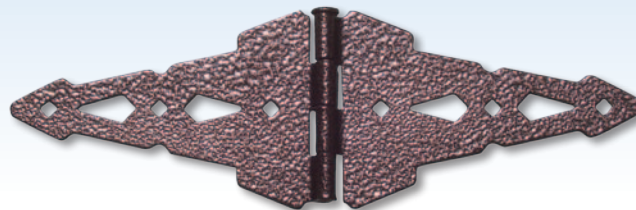

- ▶ All hardware is zinc plate steel with hammered bronze finish
- ▶ For specs and photo of hardware shown in black, please view referenced page numbers

Look for the star to quickly identify the Hammered Bronze hardware.



Also Available in Hammered Bronze

Kits:

NW38948CQ-HBZ

- ▶ See NW38948CQ on page 10

NW38949CQ-HBZ

- ▶ See NW38949CQ on page 10

NW38948WQ-HBZ

- ▶ See NW38948WQ on page 10

NW38949W24-HBZ

- ▶ See NW38949W24 on page 10

Drop Rods:

NW38305-24Q-HBZ

- ▶ See NW38305-24Q on page 11

Handles:

NW38398Q-HBZ

- ▶ See NW38398Q on page 14

8" Ornamental 'T' Hinge

NW38937Q

- ▶ Zinc plate steel with black finish
- ▶ 1 3/4" lag screws with black finish
- ▶ 20 pair per case @ 43 lbs



Also Available in
Hammered Bronze

NW38937FQ

with Fixed Pin

- ▶ Zinc plate steel with black finish
- ▶ 1 3/4" lag screws with black finish
- ▶ 20 pair per case @ 43 lbs



NW38937AQ

Un-Assembled

- ▶ Zinc plate steel with black finish
- ▶ 1 3/4" lag screws with black finish
- ▶ 20 pair per case @ 43 lbs

NW38937MDQ

- ▶ Zinc plate steel with black finish
- ▶ **3" thru-bolts for gate side**
- ▶ **3" lag screws for fence side**
- ▶ 20 pair per case @ 44 lbs

10" Ornamental 'T' Hinge

NW38933MDQ with Cotter-Pin

- ▶ Zinc plate steel with black finish
- ▶ **3" thru-bolts for gate side**
- ▶ **3" lag screws for fence side**
- ▶ 10 pair per case @ 44 lbs



NW38933FMDQ with Fixed Pin

- ▶ Zinc plate steel with black finish
- ▶ **3" thru-bolts for gate side**
- ▶ **3" lag screws for fence side**
- ▶ 10 pair per case @ 44 lbs

12" Ornamental 'T' Hinge

NW38935Q

- ▶ Zinc plate steel with black finish
- ▶ 1 3/4" lag screws with black finish
- ▶ 10 pair per case @ 52 lbs

NW38935MDQ (special order)

- ▶ Zinc plate steel with black finish
- ▶ **3" thru-bolts for gate side**
- ▶ **3" lag screws for fence side**
- ▶ 10 pair per case @ 52 lbs

8" Ornamental Heavy Duty Self-Closing 'T' Hinge

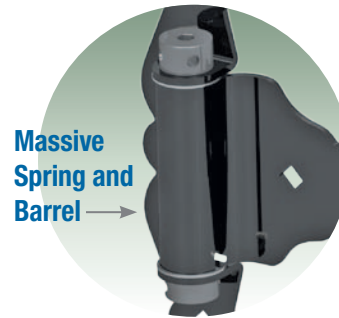

Massive
Spring and
Barrel →



NW38937HDQ

- ▶ **More Closing Power**

- ▶ Easy tension adjustment
- ▶ Easy to hold adjustment pin

8" Contemporary 'T' Hinge

NW38945Q

- ▶ Zinc plate steel with black finish
- ▶ 1 3/4" lag screws with black finish
- ▶ 20 pair per case @ 54 lbs



Also Available in
Hammered Bronze

NW38945MDQ

- ▶ Zinc plate steel with black finish
- ▶ **3" thru-bolts for gate side**
- ▶ **3" lag screws for fence side**
- ▶ 20 pair per case @ 54 lbs



NW38945SS

- ▶ Same as NW38945Q but in stainless steel with mill finish

10" Contemporary 'T' Hinge

NW38947Q

- ▶ Zinc plate steel with black finish
- ▶ 1 3/4" lag screws with black finish
- ▶ 10 pair per case @ 32 lbs

NW38947MDQ

- ▶ Zinc plate steel with black finish
- ▶ **3" thru-bolts for gate side**
- ▶ **3" lag screws for fence side**
- ▶ 10 pair per case @ 32 lbs

8" Traditional 'T' Hinge

NW38941Q

- ▶ Zinc plate steel with black finish
- ▶ 1 3/4" lag screws with black finish
- ▶ 20 pair per case @ 56 lbs



Wood Fence Hinges

Blunt 'T' Hinge

NW6172-BK

- ▶ Zinc plate steel with black finish
- ▶ 1 3/4" lag screws for fence
- ▶ 1 3/4" lag screws for gate
- ▶ 20 pair per case @ 40 lbs

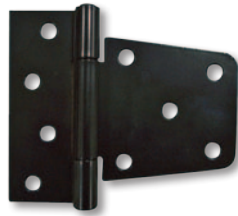

6" Universal 'T' Hinge

NW36576/6-BQ

- ▶ Zinc plate steel with black finish
- ▶ 2 1/2" lag screws for fence
- ▶ 1 3/4" lag screws for gate
- ▶ 20 pair per case @ 34 lbs

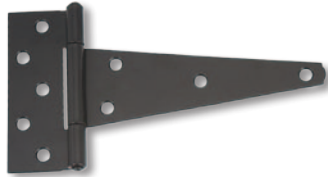

NW36576/6-M

- ▶ Zinc plate steel finish
- ▶ 2 1/2" lag screws for fence
- ▶ 1 3/4" lag screws for gate
- ▶ 20 pair per case @ 34 lbs

NW36576/6-71

- ▶ Zinc plate steel finish
- ▶ Bulk-packed without screws
- ▶ 50 each per case @ 43 lbs

NW36576/6-ZPBB (Special order only) with Brass Bushing

- ▶ Zinc plate steel with black finish
- ▶ 2 1/2" lag screws for fence
- ▶ 1 3/4" lag screws for gate
- ▶ 40 pair per case @ 59 lbs

8" Universal 'T' Hinge

NW199

- ▶ Zinc plate steel with black finish
- ▶ 2 1/2" lag screws for fence
- ▶ 1 3/4" lag screws for gate
- ▶ 20 pair per case @ 42 lbs



NW199-76 (Special order only)

- ▶ Zinc plate steel finish
- ▶ 2 1/2" lag screws for fence
- ▶ 1 3/4" lag screws for gate
- ▶ 20 pair per case @ 42 lbs

NW199-ZPBB (Special order only) with Brass Bushing

- ▶ Zinc plate steel with black finish
- ▶ 2 1/2" lag screws for fence
- ▶ 1 3/4" lag screws for gate
- ▶ 20 pair per case @ 43 lbs

8" Ornamental Screw Hook & Strap Hinge



NW38934Q

- ▶ Zinc plate steel with black finish
- ▶ 1 3/4" lag screws with black finish
- ▶ 20 pair per case @ 40 lbs

8" Ornamental Double Strap Hinge



NW38936Q

- ▶ Zinc plate steel with black finish
- ▶ 1 3/4" lag screws with black finish
- ▶ 20 pair per case @ 52 lbs

8" Ornamental Half Strap Hinge



NW38938Q

- ▶ Zinc plate steel with black finish
- ▶ 1 3/4" lag screws with black finish
- ▶ 20 pair per case @ 41 lbs

NW38938FQ with Fixed Pin

- ▶ Zinc plate steel with black finish
- ▶ 1 3/4" lag screws with black finish
- ▶ 20 pair per case @ 41 lbs

NW38938A Un-Assembled

- ▶ Zinc plate steel with black finish
- ▶ 1 3/4" lag screws with black finish
- ▶ 20 pair per case @ 40 lbs

8" Contemporary Double Strap Hinge



NW38944Q

- ▶ Zinc plate steel with black finish
- ▶ 1 3/4" lag screws with black finish
- ▶ 20 pair per case @ 61 lbs



Also Available in
Hammered Bronze

NW38944SS

- ▶ Same as NW38944Q but in stainless steel with mill finish

10" Contemporary Double Strap Hinge

NW38942Q

- ▶ Zinc plate steel with black finish
- ▶ 1 3/4" lag screws with black finish
- ▶ 10 pair per case @ 35 lbs

8" Traditional Double Strap Hinge



NW38940Q

- ▶ Zinc plate steel with black finish
- ▶ 1 3/4" lag screws with black finish
- ▶ 20 pair per case @ 54 lbs

10" Traditional Double Strap Hinge

NW38946Q

- ▶ Zinc plate steel with black finish
- ▶ 1 3/4" lag screws with black finish
- ▶ 10 pair per case @ 37 lbs

6" Universal Double Strap Hinge



NW36579/6-M

- ▶ Zinc plate steel finish
- ▶ 2 1/2" lag screws for fence
- ▶ 1 3/4" lag screws for gate
- ▶ 20 pair per case @ 35 lbs

8" Contemporary Butterfly Hinge



NW38943Q

- ▶ Zinc plate steel with black finish
- ▶ 1 3/4" lag screws with black finish
- ▶ 20 pair per case @ 54 lbs

8" Traditional Butterfly Hinge



NW38943T

- ▶ Zinc plate steel with black finish
- ▶ 1 3/4" lag screws with black finish
- ▶ 20 pair per case @ 54 lbs

Adjustable Double Flange Hinge

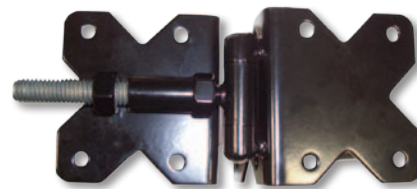

SV38965-BK

- ▶ Zinc plate steel with black finish
- ▶ Post flange: 3.5"(H) x 3.25"(W) x 3.25(D)
- ▶ Gate flange: 3.5"(H) x 3.25"(W) x 1.50(D)
- ▶ 12 pair per case @ 43 lbs

Have Questions? Need Answers?

Are your needs custom, replacement, or current stock?

- ▶ Call Us: (813) 988-2628
- ▶ Fax Us: (866) 988-3465
- ▶ Email Us: fence@nationwideindustries.com
- ▶ Visit our Web: www.nationwideindustries.com

CornerStone® Self-Closing Nylon Hinges and Hook & Eye

CornerStone® Series Self-Closing Nylon Hinges

Produced with durable glass-filled nylon
1/4" Allen wrench included for tension adjustment

CornerStone® Fully Adjustable Hinge

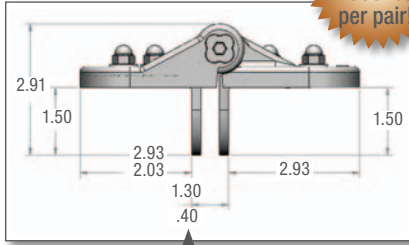
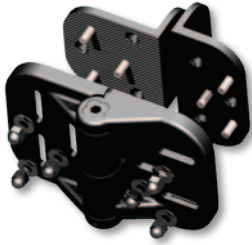

Point-Load Tested to 1500 lbs per pair!

Patented

Double dimensions indicate range of adjustability

- CH300F-BK Black w/stainless steel self-threading screws included
- CH300F-WH White w/stainless steel self-threading screws included
- CH300F-SD-BK Black w/stainless steel self-drilling screws included
- CH300F-SD-WH White w/stainless steel self-drilling screws included
- ▶ Both flanges: 4.25"(H) x 2.88"(W) x 1.50"(D)
- ▶ Back plates allow horizontal and vertical adjustability
- ▶ 20 pair per case @ 42 lbs

CornerStone® Horizontally Adjustable Hinge

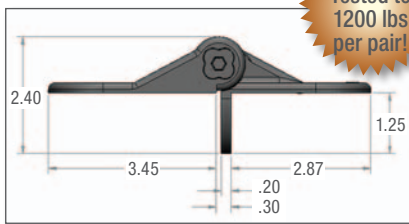

Point-Load Tested to 1200 lbs per pair!

Slotted, serated holes for horizontal holding power
Patented

- CH300H-BK Black w/stainless steel self-threading screws included
- CH300H-WH White w/stainless steel self-threading screws included
- CH300H-SD-BK Black w/stainless steel self-drilling screws included
- CH300H-SD-WH White w/stainless steel self-drilling screws included
- ▶ Both flanges: 4.25"(H) x 2.88"(W) x 1.25"(D)
- ▶ 20 pair per case @ 24 lbs

CornerStone® Fixed Position 4" Hinge

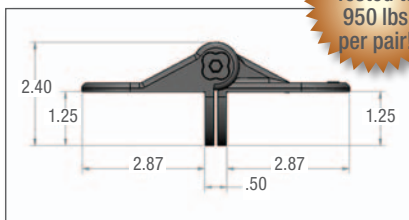

Point-Load Tested to 950 lbs per pair!

- CH300N-BK Black
- CH300N-WH White
- ▶ Both flanges: 4.25"(H) x 2.88"(D) x 1.25"(D)
- ▶ Stainless steel screws included
- ▶ 20 pair per case @ 31 lbs

Patented

6" Heavy Duty Strap with 1/2" Screw Hook



NW284-76

- ▶ Zinc plate steel finish
- ▶ 12 pair per case @ 21 lbs

12" Heavy Duty Strap with 5/8" Screw Hook



NW255/38931-26

- ▶ Zinc plate steel with black finish
- ▶ 1 3/4" lag screws with black finish
- ▶ 12 pair per case @ 42 lbs

NW255/38931-GV

- ▶ HDG finish
- ▶ 1 3/4" lag screws with HDG finish
- ▶ 12 pair per case @ 42 lbs

NW255-71

- ▶ Zinc plate steel finish
- ▶ Without screws – bulk packed
- ▶ 50 each per case @ 42 lbs

1/2" X 4" Screw Hook & Eye Hinge



NW38603

- ▶ Zinc plate steel finish
- ▶ 50 pair per case @ 56 lbs

NW38603-GV

- ▶ HDG finish
- ▶ 50 pair per case @ 56 lbs

5/8" X 5" Screw Hook & Eye Hinge

NW38931

- ▶ Zinc plate steel finish
- ▶ 20 pair per case @ 56 lbs

Standard Gravity Latch

NW38204Q

- ▶ Zinc plate steel with black finish
- ▶ Screws with black finish
- ▶ .38" Strike bar with ball tip
- ▶ Pad-lockable
- ▶ 50 each per case @ 27 lbs



NW38204-76Q

- ▶ Zinc plate steel finish
- ▶ Screws with zinc plate finish
- ▶ .38" Strike bar with ball tip
- ▶ Pad-lockable
- ▶ 50 each per case @ 27 lbs

NW38204SSM

- ▶ Same as NW38204Q but in stainless steel with mill finish

NW38204NC-76

with Cable

- ▶ Zinc plate steel finish
- ▶ Screws with zinc plate finish
- ▶ With 13" cable, clip and o-ring for access on opposite side of fence
- ▶ .38" Strike bar with ball tip
- ▶ Pad-lockable
- ▶ 50 each per case @ 27 lbs

Standard Gravity Latch with Floating Bar



NW38203Q

- ▶ Zinc plate steel with black finish
- ▶ Screws with black finish
- ▶ .38" Strike Bar with ball tip
- ▶ Pad-lockable
- ▶ 50 each per case @ 27 lbs

Heavy Duty Gravity Latch



NW38338/R

- ▶ Zinc plate steel with black finish
- ▶ Screws with black finish
- ▶ .48" Strike bar with 90° bend
- ▶ Pad-lockable
- ▶ 20 each per case @ 28 lbs

NW38338A/R-26 with Cable

- ▶ Zinc plate steel with black finish
- ▶ Screws with black finish
- ▶ With 13" cable, clip and o-ring for access on opposite side of fence
- ▶ .48" Strike bar with 90° bend
- ▶ Pad-lockable
- ▶ 20 each per case @ 30 lbs

Heavy Duty Gravity Latch with Floating Bar



NW38340Q

- ▶ Zinc plate steel black finish
- ▶ Screws with black finish
- ▶ .48" Strike bar
- ▶ Pad-lockable
- ▶ 25 each per case @ 42 lbs

NW38340-M

- ▶ Same as NW38340Q but with zinc plate steel finish

NW38340-CABLE with Stainless Pull Cable

- ▶ Zinc plate steel black finish
- ▶ Screws with zinc plate finish
- ▶ .48" Strike bar
- ▶ Pad-lockable
- ▶ 25 each per case @ 42 lbs

Email Us: fence@nationwideindustries.com

Call Us: (813) 988-2628

Wood Fence Latches

90° Strike Gravity Latch



NW38204AQ

- ▶ Zinc plate steel with black finish
- ▶ Screws with black finish
- ▶ .38" Strike bar with 90° bend and ball tip
- ▶ Pad-lockable
- ▶ 50 each per case @ 28 lbs

Standard Post Latch

NW38308Q

- ▶ Zinc plate steel with black finish
- ▶ Screws with black finish
- ▶ Spring activated release lever
- ▶ Two-sided entry
- ▶ Reversible (right or left handed)
- ▶ Pad-lockable on one side only
- ▶ 20 each per case @ 33 lbs

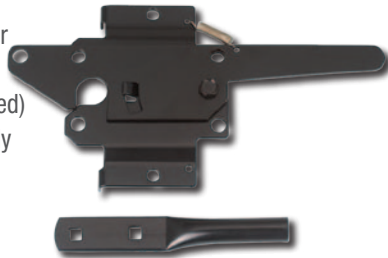

Also Available in
Hammered Bronze

NW38308SS

- ▶ Same as NW38308Q but in stainless steel with mill finish

NW38308NUA-Q

- ▶ Zinc plate steel with black finish
- ▶ Screws with black finish
- ▶ Spring activated release lever
- ▶ Two-sided entry
- ▶ Reversible (right or left handed)
- ▶ Pad-lockable on two sides
- ▶ Bent handle design
- ▶ 20 each per case @ 33 lbs

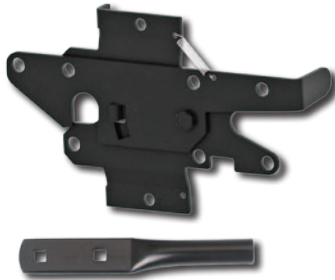

Fork Latch Kit with Handle

NW6185-BK

- ▶ Zinc plate steel with black finish
- ▶ Simple to use latch
- ▶ Avoids most sagging problems
- ▶ Built-in handles and gate stop
- ▶ 20 each per case @ 44 lbs

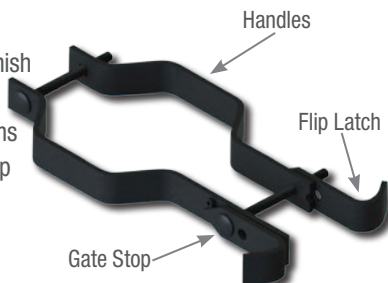

Contemporary Post Latch

NW38310WQ

- ▶ Larger opening allows for more play of strike bar



NW38310Q

- ▶ Zinc plate steel with black finish
- ▶ Screws with black finish
- ▶ 9" Gate handle
- ▶ Slide-switch lock on opposite side
- ▶ Pad-lockable on both sides
- ▶ 20 each per case @ 43 lbs



Also Available in
Hammered Bronze

Round Bar Thumb Latch

NW283-26

- ▶ Zinc plate steel with black finish
- ▶ Screws with black finish
- ▶ 9" Gate handle
- ▶ Round locking lever bar
- ▶ Pad-lockable
- ▶ 25 each per case @ 38 lbs



Improved and designed
to avoid falling out!

Ornamental Thumb Latch Kit

NW38307 - 6" Lever

NW38306A - 7" Lever

- ▶ Zinc plate steel with black finish
- ▶ Screws with black finish
- ▶ 9" Gate handle
- ▶ Locking lever bar is 'flat'
- ▶ 25 each per case @ 37 lbs



Also Available in
Hammered Bronze



Improved and designed
to avoid falling out!



Flip Latch

NW6169

- ▶ Commercial grade
- ▶ Great for dumpster use
- ▶ Pad-lockable
- ▶ Zinc plate steel with black powder coated finish
- ▶ Stainless steel through-bolt hardware included
- ▶ 10 each per case @ 37 lbs

Slide-Bar Latch



NW38339Q

- ▶ Zinc plate steel with black finish
- ▶ Screws with black finish
- ▶ 3" Throughbolts for latch
- ▶ 1" Screws for keeper
- ▶ Pad-lockable
- ▶ 60 each per case @ 42 lbs

Round Rail Loop Latch

NW38301Q

- ▶ Zinc plate steel finish
- ▶ Screws with HDG finish
- ▶ 60 each case @ 43 lbs

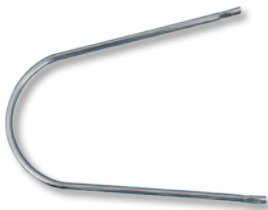

Split Rail Loop Latch

NW38302Q

- ▶ Zinc plate steel finish
- ▶ Screws with HDG finish
- ▶ 60 each per case @ 43 lbs



All-Purpose Latch Kit



NW38341-26

- ▶ Zinc plate steel with black finish
- ▶ Screws with black finish
- ▶ 20 each per case @ 36 lbs

NW38341-GV

- ▶ HDG finish
- ▶ Screws with HDG finish
- ▶ 20 each per case @ 36 lbs

* All kits contain gravity latch with cable



NW-S-Latch-ZP

- ▶ Zinc plate steel finish
- ▶ Screws with zinc plate finish
- ▶ 20 each per case @ 36 lbs

Contains same "U" shape striker bar, "U" shape staple and handle as the All Purpose Latch above. Does not include the gravity latch with cable but instead includes a flat stake keeper.

Wood Fence Latches

Keystone Advantage™ Series - Patented

Heavy Duty Design with Weather Resistant Glass-Filled Nylon Construction

Ltd
LIFETIME
Warranty!

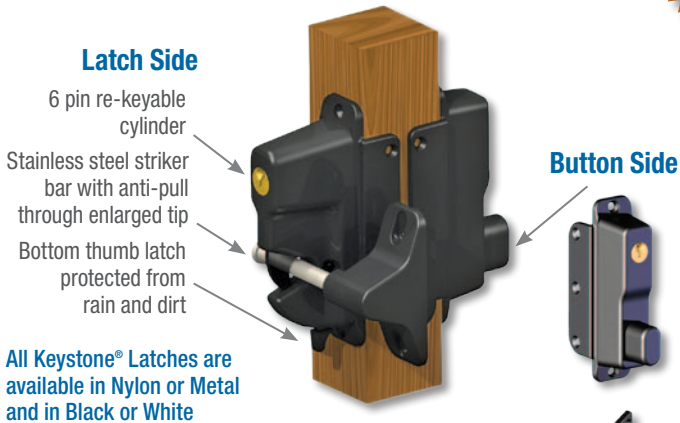

All Keystone® Latches are available in Nylon or Metal and in Black or White

Two-Sided Lockable Latch

KLADV-P2-BK Black (Nylon)

- ▶ Locking feature accessible from both sides
- ▶ Reversible for right-hand or left-hand use
- ▶ Glass-filled nylon housing
- ▶ Thumb release button on one side, gravity latch lever on opposite side
- ▶ Stainless steel screws included
- ▶ 20 each per case @ 23 lbs

All Keystone® Advantage 2-Sided Latches are packed with a durable Plastic Marking Template for installation.

KLADV-M2-BK Black (Zinc diecast)

- ▶ Same as KLADV-P2 but with zinc die cast housing
- ▶ 20 each per case @ 48 lbs



One-Sided Lockable Latch

KLADV-P1-BK Black

- ▶ Same as KLADV-P2 above but with locking (gravity latch lever) on one side
- ▶ 20 each per case @ 17 lbs

KLADV-M1-BK Black (Zinc diecast)

- ▶ 20 each per case @ 31 lbs



The Keystone® X-eXternal Mount Latch

Best Stainless Steel External Spindle Design in the Industry - Patent Pending

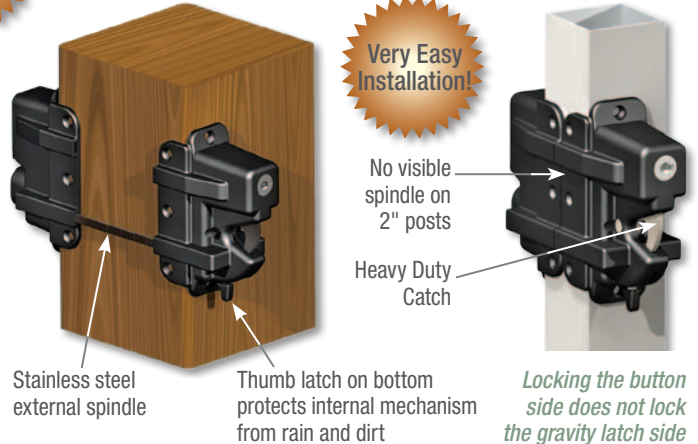

No need to drill spindle holes!

Two-Sided

KLX-P2-BK Black (Nylon)

- ▶ Marked in 1/2" increments for quick, easy and accurate fitting to post sizes 2" - 5"
- ▶ Flat design safely encloses spindle ends
- ▶ 20 each per case @ 22 lbs

For Thicker Posts

KLX-Spindle-10

- ▶ Longer spindle for gate posts over 5" thick

One-Sided

KLX-P1-BK Black (Nylon)

- ▶ Features Latch only
- ▶ 20 each per case @ 15 lbs



MANTA™

MAGNETIC Latch

Ordering Information:

Number	Quantity	Weight
MANTA-L-BK	12 per box	21 lbs
MANTA-L-WH	12 per box	21 lbs

Patent Pending

Lock Thru™ Latch



LT1-BK

- ▶ Open the padlock from either side of the gate
- ▶ Simple to lock or unlock as the latch rotates to you
- ▶ Zinc-plated steel & powder coated
- ▶ Mounting hardware included (padlock not included)
- ▶ Compatible with left or right hand gates
- ▶ 20 each per case @ 24 lbs

Avoid
Walk
Arounds!

* Patent pending

Contemporary Walk Gate Kit

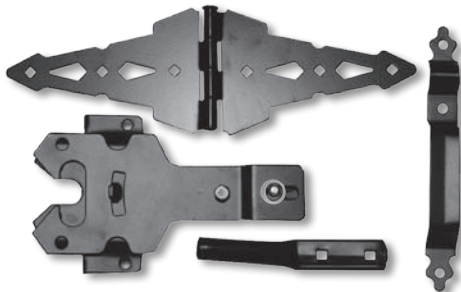

NW38948CQ

- ▶ Zinc plate steel with black finish
- ▶ Screws with black finish
- ▶ Includes: pair of 8" double strap hinges, post latch and 9" handle
- ▶ 10 kits per case @ 53 lbs

Also Available in
Hammered Bronze

Contemporary Drive Gate Kit

NW38949CQ

- ▶ Same as NW38948CQ kit with an additional 24" drop rod and pair of hinges (includes 2 pair of hinges)
- ▶ 6 kits per case @ 63 lbs

Also Available in
Hammered Bronze

Traditional Walk Gate Kit

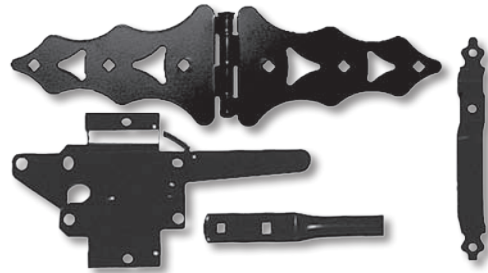

NW38948Q

- ▶ Zinc plate steel with black finish
- ▶ Screws with black finish
- ▶ Includes: pair of 8" double strap hinges, post latch with return spring and 9" handle
- ▶ 10 kits per case @ 47 lbs

Traditional Drive Gate Kit

NW38949Q

- ▶ Same as NW38948Q kit with an additional 24" drop rod and pair of hinges (includes 2 pair of hinges)
- ▶ 6 kits per case @ 58 l

Western Walk Gate Kit

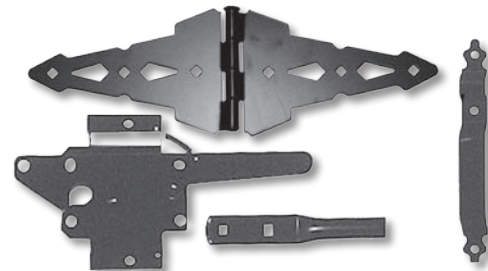

NW38948WQ

- ▶ Zinc plate steel with black finish
- ▶ Screws with black finish
- ▶ Includes: pair of 8" double strap hinges, post latch with return spring and 9" handle
- ▶ 10 kits per case @ 51 lbs

Also Available in
Hammered Bronze

Western Drive Gate Kit

NW38949W24

- ▶ Same as NW38948WQ kit with an additional 24" drop rod and pair of hinges (includes 2 pair of hinges)
- ▶ 6 kits per case @ 62 lbs

Also Available in
Hammered Bronze

Wood Gate Drop Rods, Gate Wheels and Caps



24" Available in Hammered Bronze

Heavy Duty Drop Rods

- NW38305-18Q** 18" **Zinc plate steel** with Black finish
20 each per case @ 36 lbs
- NW38305-18/ZP** 18" **Zinc plate steel- unpainted**
20 each per case @ 36 lbs
- NW38305-24Q** 24" **Zinc plate steel** Black finish
20 each per case @ 44 lbs
- NW38305/24-76Q** **Zinc plate steel - unpainted**
20 each per case @ 44 lbs
- NW38305-24SS** **Stainless steel - unpainted**
20 each per case @ 44 lbs
- NW38305-24SSB** **Stainless steel** with Black finish
20 each per case @ 44 lbs
- NW38305-24SSW** **Stainless steel** with White finish
20 each per case @ 44 lbs
- NW38305-36Q** 36" **Zinc plate steel** with Black finish
20 each per case @ 64 lbs
- NW38305-48Q** 48" **Zinc plate steel** with Black finish
10 each per case @ 41 lbs



- ▶ 5/8" diameter
- ▶ Screws included
- ▶ Dual guides
- ▶ Pad-lockable
- ▶ Retention-ears for theft prevention



Drop Rods with Holder

- NW38305H-24Q**
- NW38305H-36Q**
- NW38305H-48Q**

- ▶ No locking nibs
- ▶ Includes holder for "up" position



holder

Gate Wheels

GW2-BK Black (For Wood Gates)

- ▶ Zinc plated steel with powder-coated finish
- ▶ Composite wheel designed for rougher uneven surfaces and large temperature ranges
- ▶ Swivel design for ease of use
- ▶ Easily reversible for use on left or right-handed gates
- ▶ Nationwide's V-notch™ styling
- ▶ May be used on any flat surface
- ▶ Lag screws included
- ▶ 10 each per case @ 38 lbs



GW2-BK



GW1-SS-BK Black (Stainless Steel Design for Vinyl Gates)

- ▶ 10 each per case @ 29 lbs



GW3-BK Black (For Chain Link Gates)

- ▶ 10 each per case @ 46 lbs

Copper Plated Stainless Steel Cap

A durable alternative that combines stainless steel with the look of copper.

NW6180-44-CP

- ▶ Fits a 4 x 4 post measuring 3 1/2" square
- ▶ Glues on to post
- ▶ 50 per case @ 6 lbs



Plastic Caps

4" Wood Post Plastic Cap

NW287-21

- ▶ Fits a 4 x 4 post measuring 3 5/8" square
- ▶ 500 each per case @ 37 lbs

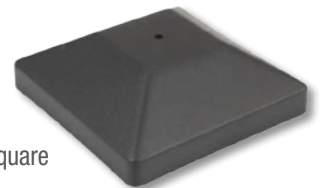

6" Wood Post Plastic Cap

NW298-21

- ▶ Fits a 6 x 6 post measuring 5 3/4" square
- ▶ 200 each per case @ 35 lbs
- ▶ Made of durable HDPE plastic in black
- ▶ Logo option available (minimum quantity required)
- ▶ Also available without top hole (minimum quantity required)
- ▶ Made of durable HDPE plastic in black

Premium Caps for Wood Posts

Miter-less Wood Caps

These slip-over, Miter-less wood caps are made from a single solid block of mahogany wood. Eliminating the miter joints has solved the age old problem of post caps splitting at the corners. By making the cap out of one solid piece of wood, it has eliminated the need for any glue or staples to hold the cap together.



Traditional

WPC-312-TRD

- ▶ Fits a standard 4 x 4 post measuring 3 1/2" square
- ▶ 45 per case @ 35 lbs



WPC-334-TRD

- ▶ Fits a 4 x 4 post measuring 3 3/4" square
- ▶ 45 per case @ 35 lbs

Pyramid

WPC-312-PYR

- ▶ Fits a standard 4 x 4 post measuring 3 1/2" square
- ▶ 45 per case @ 35 lbs



WPC-334-PYR

- ▶ Fits a 4 x 4 post measuring 3 3/4" square
- ▶ 45 per case @ 35 lbs

New England

WPC-312-NWENG

- ▶ Fits a standard 4 x 4 post measuring 3 1/2" square
- ▶ 45 per case @ 35 lbs



WPC-334-NWENG

- ▶ Fits a 4 x 4 post measuring 3 3/4" square
- ▶ 45 per case @ 35 lbs

WPC-534-NWENG

- ▶ Fits a 6 x 6 post measuring 5 1/2 to 5 3/4" square
- ▶ 20 per case @ 45 lbs



theirs



ours

Copper and Stainless Steel Caps

The 20 gauge copper post caps are made of 100% copper and have a natural look that will patina to a green color over time. The stainless steel caps are 20 gauge stainless steel. The caps will fit 4 X 4 and 6 X 6 posts and include 2 screws for mounting.

Copper

WPC-312-COPP

- ▶ Fits a standard 4 x 4 post measuring 3 1/2" square
- ▶ 25 per case @ 6 lbs



WPC-534-COPP

- ▶ Fits a 6 x 6 post measuring 5 1/2 to 5 3/4" square
- ▶ 25 per case @ 11 lbs

Stainless Steel

WPC-312-SS

- ▶ Fits a standard 4 x 4 post measuring 3 1/2" square
- ▶ 25 per case @ 6 lbs



WPC-534-SS

- ▶ Fits a 6 x 6 post measuring 5 1/2 to 5 3/4" square
- ▶ 25 per case @ 11 lbs

Metal-Wood Combination

4 X 4 Post Size Only

- ▶ Order a copper or stainless steel cap and a Traditional 4 X 4 Miter-less wood cap for a metal-wood combination



WPC-312-COPP
WPC-312-TRD



WPC-312-SS
WPC-312-TRD

True Size Caps

For 4", 5" and 6" True Post Sizes, Special Order

WPC-400-NWENG - for 4"

WPC-500-PYR- for 5"

WPC-600-NWENG - for 6"

- ▶ Contact Customer Service for minimum quantities and lead time

Bumpers and Braces

Nylon Gate Handle with Bumper

NW6143S-BK Black

NW6143S-WH White

- ▶ Made with durable glass-filled nylon with UV inhibitors
- ▶ Flanges are each 2"(W) x 1.75"(D) for durable attachment
- ▶ Overall height is 4.5" and handle is 1" deep
- ▶ Very comfortable and easy to grasp
- ▶ Stainless steel screws included
- ▶ 50 each per case @ 25 lbs
- ▶ Also available in quantities of 10

Avoids Damage!

Rubber pad backing absorbs gate slamming shock, reducing latch wear



Nylon Gate Bumper

NW6186-SD-BK

- ▶ Made with durable glass-filled nylon with UV inhibitors
- ▶ Flanges are each 2"(W) x 1.75"(D) for durable attachment
- ▶ Overall height is 4.5"
- ▶ Stainless steel screws included
- ▶ 50 each per case @ 22 lbs
- ▶ Also available in quantities of 10

Avoids Damage!



Hydraulic Gate Closers



GC2-BK Black

▶ **GC2-WH** White

- ▶ Works with gates up to 125 lbs
- ▶ Works with gates widths up to 54"
- ▶ Adjustable closing speed and adjustable latching speed
- ▶ 90° hold open feature
- ▶ Maximum opening of 90°
- ▶ Powder coated steel
- ▶ 12 each per case @ 30 lbs

GC1-BK Black

- ▶ Works with gates up to 150 lbs
- ▶ Works with gates widths up to 54"
- ▶ Adjustable closing speed
- ▶ 90° hold open feature
- ▶ Powder coated steel
- ▶ 8 each per case @ 43 lbs



Gate Braces for Vinyl and Wood Fences

NW6132-BK Black or **NW6132-WH** White

- ▶ Aluminium construction
- ▶ Available in powder-coated black or white
- ▶ Fits 4' x 4' to 6' x 6' gates
- ▶ 10 per case @ 54 lbs



The Cost-effective Brace that Works!

Sturdy Attachment Brackets



Adjustable

Guards Against Sagging and Warping!

Visit our Web: www.nationwideindustries.com

6" Standard Gate Handle

NW257-26Q

- ▶ Zinc plate steel with black finish
 - ▶ Screws with black finish
 - ▶ 100 each per case @ 19 lbs
- Also available in quantities of 50



Also Available in
Hammered Bronze

9" Standard Gate Handle

NW38398Q

- ▶ Zinc plate steel with black finish
 - ▶ Screws with black finish
 - ▶ 100 each per case @ 31 lbs
- Also available in quantities of 50



9" Ornamental Gate Handle

NW38396Q

- ▶ Zinc plate steel with black finish
 - ▶ Screws with black finish
 - ▶ Does Not Match and fits the handle from the NW38307 Thumb Latch Kit
 - ▶ 100 each per case @ 43 lbs
- Also available in quantities of 50



9" Ornamental Gate Handle

NW38307HANDLE

- ▶ Zinc plate steel with black finish
 - ▶ Screws with black finish
 - ▶ **Matches and fits the handle from the NW38307 Thumb Latch Kit**
 - ▶ 100 each per case @ 43 lbs
- Also available in quantities of 50



Nylon Gate Handle

NW314S-BK Black

NW314S-WH White

- ▶ Made with durable glass-filled nylon with UV inhibitors
 - ▶ Flanges are each 1.5"(W) x 1.25"(D) for durable attachment
 - ▶ Overall height is 5" and handle is .75" deep
 - ▶ Very comfortable and easy to grasp
 - ▶ Stainless steel screws included
 - ▶ 200 each per case @ 29 lbs
- Also available in quantities of 50



2" X 4" Rail Mounting Bracket – Steel

NW288-MI

- ▶ Zinc plate steel finish
- ▶ 400 each per case @ 45 lbs

NW288-GV

- ▶ HDG finish
- ▶ 400 each per case @ 45 lbs



10" Gate Spring

NW38304-PQ

- ▶ Zinc plate steel with black finish
- ▶ Screws with black finish
- ▶ Adjustable tension
- ▶ 40 each per case @ 53 lbs



5/16" X 2" Lag Screw

NW5162

- ▶ Zinc plate steel with black finish
- ▶ 1200 per case @ 27 lbs

NW5162Q

- ▶ HDG steel with black finish
- ▶ 1200 each per case @ 46 lbs



Gate Anti-Sag Kit – Steel

NW38309Q

- ▶ Zinc plate steel finish
- ▶ Screws with zinc plate finish
- ▶ Cable length is 9'
- ▶ 50 kits per case @ 31 lbs

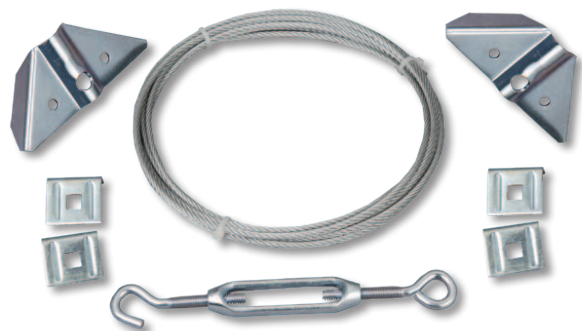

NW38309SSM

- ▶ Same as NW38309Q but in stainless steel with mill finish

Ask about our other Fence Hardware Catalogs



Innovative Fence and Railing Hardware



Vinyl Fence Hardware



Ornamental Fence Hardware

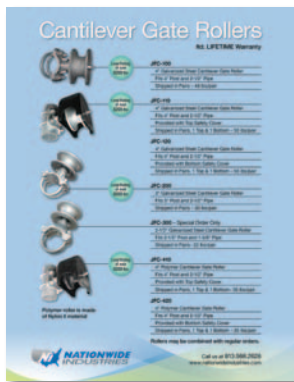

Cantilever Gate Rollers and Accessories



Keyless Gate Locks



Chain Link Gate Hardware

CornerStone®
The Million Cycle
Self-Closing Nylon Hinges

Keystone® Advantage
Heavy Duty
Key-Lockable Latches

Keystone® X
eXternal Mount
Key-Lockable Latches

OrnaMAG™
Magnetic
Metal Latches

Manta™
Magnetic
Nylon Latches

AquaLatch™
Magnetic Pool
Safety Latches

V-Notch™
Hinges and
Latches



**VINYL FENCE, DECK AND RAILING
MANUFACTURERS ASSOCIATION**
A Division of the American Fence Association

